

*Fristom*

# ELECTRICAL WIRING SYSTEMS FOR TRAILERS

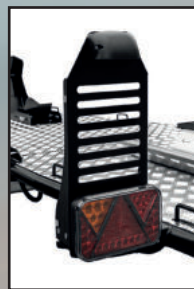

*... all you need is light*

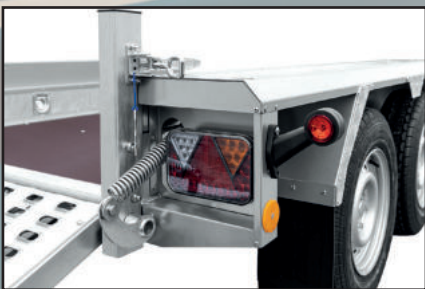

**FRISTOM Spółka z o.o. Sp. k.** is a Company with family traditions, dealing with the production of lighting and electrical harnesses for the Automotive industry. The beginnings of the Company date back to the previous generation, and under the present name “**FRISTOM Spółka z o.o. Sp. k.**” it has been present on the market since **1995**. Through the years we have been constantly improving the quality of our products, and expanding our portfolio and sales range. All the activities we undertake are performed with passion. Our main goal is to provide comprehensive service, and ensure customer satisfaction, by designing, manufacturing, and marketing, the highest-quality lamps. Our products are successfully used in heavy transport, logistics, forwarding, agriculture, and private vehicles. Our main customers are wholesalers and distribution networks, as well as trailer and semi-trailer manufacturers in this country and abroad. The machines and equipment we use are **the absolute best in the Automotive industry**. There is no cutting corners with us, and **we treat each product exceptionally** – it will one day reach the end user, who must be satisfied with it. Therefore, we use not only the best materials, but also the most perfect and modern machines in their production. They provide not only **excellent quality** but also **reliability in the manufactured products**. In order to completely eliminate errors and damage, to increase the efficiency, and therefore the competitiveness, of our Company, we constantly rely on full automation of production. It is thanks to all this that we deliver excellent and reliable products. The quality of our products and work is confirmed by the ISO 9001:2015 certificate

**Why FRISTOM?**

You will receive comprehensive service with us. We will provide a cable harnesses, rear lamps, number plate lighting, marker lamps ..., all electrics that are necessary in 12V trailers. We are specialists in this field. All lamps are EMC certified authorizing the installation of our products on trailers. We have extensive technical knowledge thanks to which we will help you choose the right one lighting and cable harnesses in accordance with the regulations, adjusted to the length of the trailer. We have been trusted by many companies not only from Poland, but also from Europe.

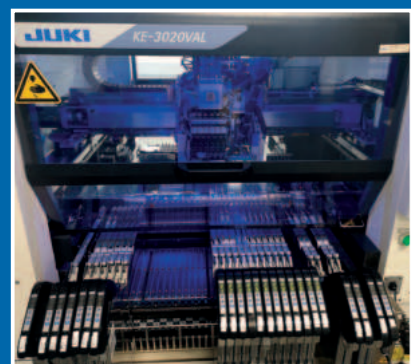

*... all you need is light*

**Fristom**



**„Quality, Honesty, Reliability, Responsiveness, Professionalism – these are the words that come to mind after 20 years of cooperation when we say FRISTOM”**  
– **TADEUSZ NOCKOSKI Ta-No Trailers Company Owner**

**„Fristom was the brand we chose from the beginning of our road in the design and build of our caravan, because of their contemporary look of their **products and high quality finishes**. And Fristom will be the base in what regards lighting auto parts, for our future projects.”**  
– **STEFAN SECUIU Chief Designer in FIN MANAGEMENT GROUP SRL**

**„Fristom is a company with great products, beside that they do everything to help you out when needed. Deliverys is always perfect and there always available to help customers”**  
– **Team VDM Trailers van de MANAKKER JAMEY**

**„We have been cooperating with Fristom for many years – a partner worth recommending”**  
– **Bogdan Matecki, CEO at DEBON Sp. z o.o.**

**„We are **delighted** with the Fristom **product** range and with the treatment we receive in all our purchases”**  
– **Diego Rodríguez CEO at REMOLQUES RODRIGUEZ S.L.**

**„Fristom is a **reliable** and **honest** family company, worth recommending! **Professional approach**, full commitment, contact and cooperation at the **highest level**, and extreme **care to the smallest detail** of the offered products – lamps and electric harnesses.”**  
– **Sebastian Ślubowski – Purchasing Manager at STALKO**

Plug 7 Pins Innerwork / Wtyk 7 Pinów  
Plug view / Widok od wtyczki / ISO 1724

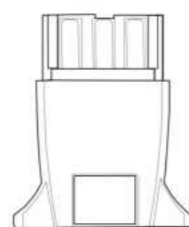
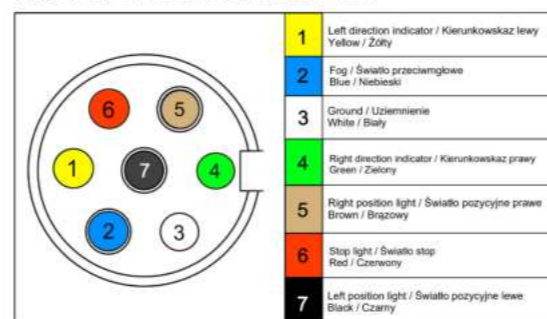

L1 L2



### 4-FUNCTIONAL LAMP:

STOP LIGHT  
REAR POSITION LIGHT  
INDICATOR  
FOG LIGHT

### 3-FUNCTIONAL LAMP:

STOP LIGHT  
REAR POSITION LIGHT  
INDICATOR

### BAYONET 5 PIN

Yellow / Żółty  
Plug view / Widok wtyczki



### BAYONET 4 PIN

Green / Zielony  
Plug view / Widok wtyczki



### O-RING

Silicone sealing resistant not only to demanding weather conditions but also salinity and oils.

### PLUG CORE

Equipped with a pressure collar assuring equal sealing pressure on the O-ring.

### COVER SLEEVE

Made of flexible and durable material called elastomer TPE-S. Characterized not only by good flexibility at low temperatures but also good aging properties.

### GASKET

Makes it easier to tighten the nut. Nut seals the connection between the collar of the shielding sleeve and the collar of the plug core.

### NUT

ergonomically shaped, allows for a secure grip and easy fastening on the bayonet socket. Clasp revision makes it possible to check whether the nut has been fastened correctly. Correctness of the clasp also heard through the so-called "Click". The guidance of the dowel pins facilitates the fastening nuts.

### CLAMP BAND

used in the automotive industry, it is clamped automatically, which always guarantees the same clamping force.

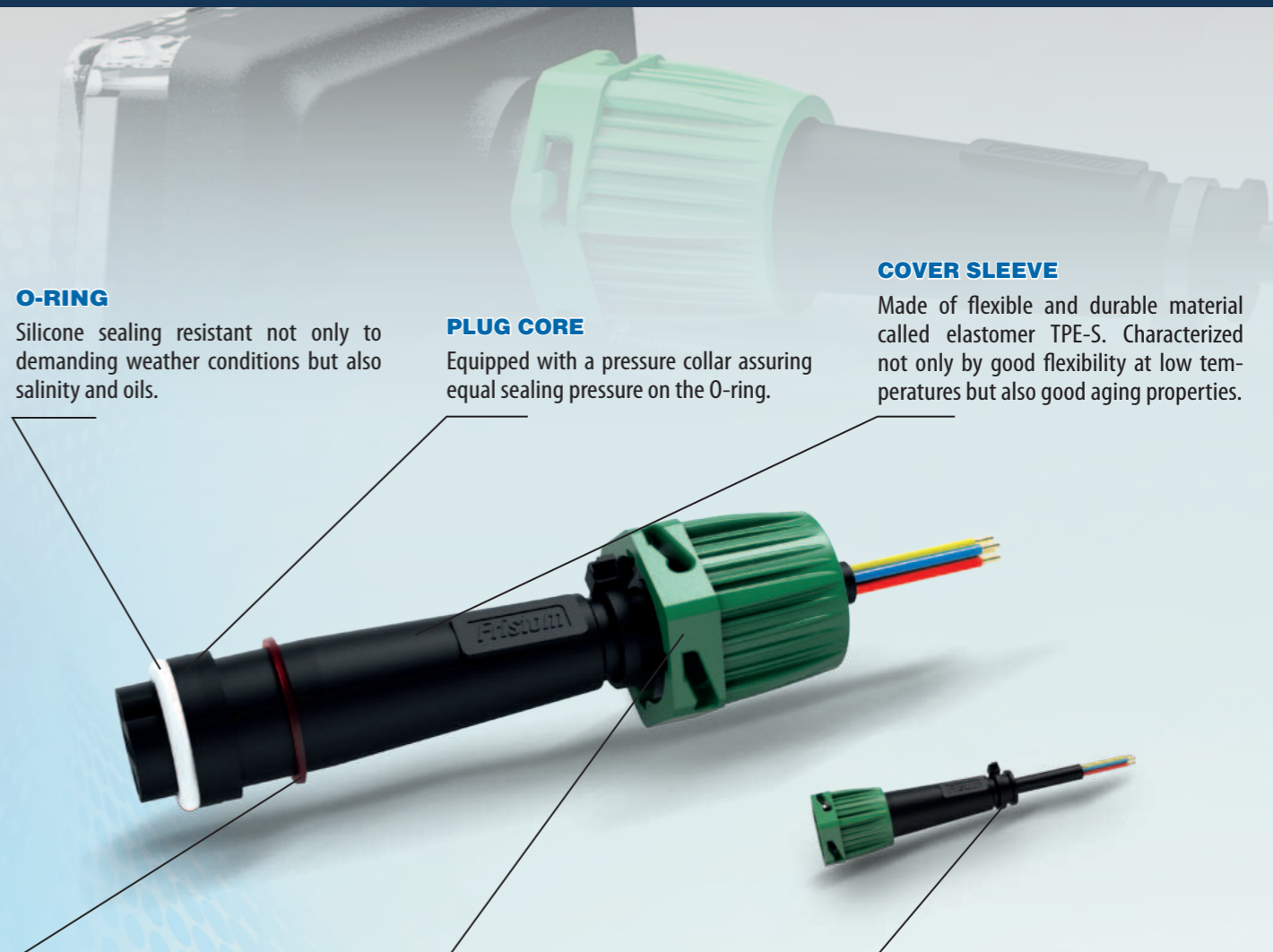

# NEW

## IP 67 BAYONET connector

### PRODUCTION:

FRISTOM  
Spółka z ograniczoną odpowiedzialnością i Sp. K.  
ul. Przemysłowa 5  
POLAND, 86-014 Sicienko

### EXPORT:

mobile +48 609 909 456  
bstaniaszek@fristom.com.pl  
mobile +48 731 088 883  
wtomczak@fristom.com.pl

mobile +48 607 843 275  
rcardona@fristom.com.pl  
mobile +48 794 792 929  
mjanus@fristom.com.pl



# ONE lamp, TWO faces!

A NEW LAMP available with **LIGHT CONTROL SYSTEM**.

Plug 7 Pins Innerwork / Wtyk 7 Pinów  
Plug view / Widok od wtyczki / ISO 1724

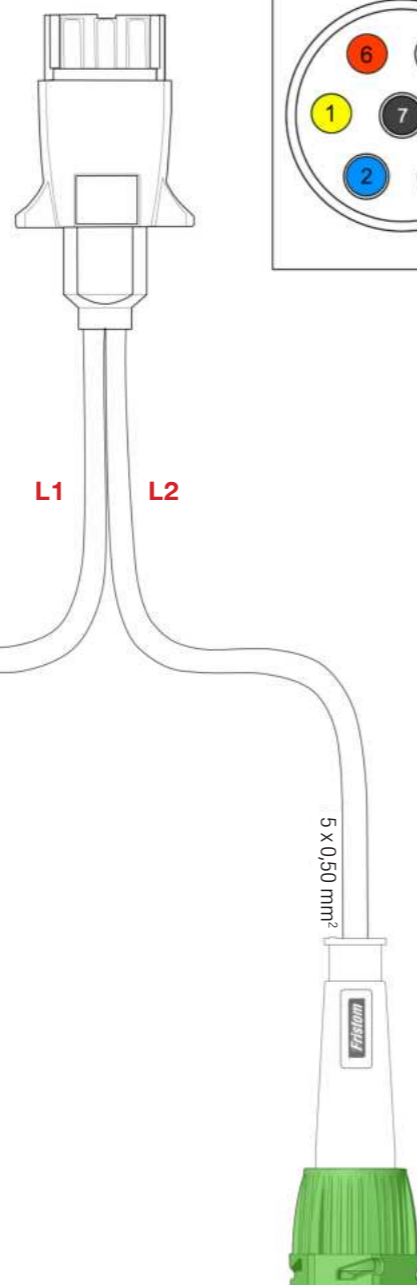
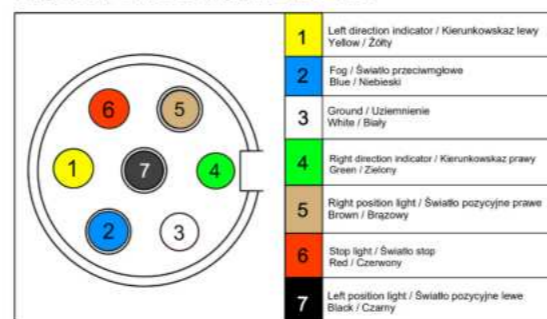

#### 4-FUNCTIONAL LAMP:

- STOP LIGHT
- REAR POSITION LIGHT
- INDICATOR
- FOG LIGHT

#### 4-FUNCTIONAL LAMP:

- STOP LIGHT
- REAR POSITION LIGHT
- INDICATOR
- FOG LIGHT

Universal LED lamp – low power consumption  
European homologation E9  
ElectroMagnetic Compatibility (EMC) homologate on shock-resistance – PC lampshade reverse polarity protection system

#### Lamp functions:

- rear running light
- number plate light
- STOP light
- indicator
- fog light (depending on the version)
- reversing light (depending on the version)
- reflector (triangle)

#### Technical specification:

- supply voltage: 12–15V DC
- operating temperature: -40°C to +55°C
- lamp is resistant to any weather conditions
- lamp is fully airtight

#### Power consumption:

- rear running light
- + number plate light:
- version without number plate light:
- STOP light:
- indicator:
- reversing light:
- fog light:

#### Power consumption / Rated power:

- rear running light
- + number plate light:
- version without number plate light:
- STOP light:
- indicator:
- reversing light:
- fog light:

#### FT-270 LED

- 12V = 0.1A
- 12V = 0.05A
- 12V = 0.2A
- 12V = 0.2A
- 12V = 0.2A
- 12V = 0.2A

- 12V = 1.2W
- 12V = 0.6W
- 12V = 2.4W
- 12V = 2.4W
- 12V = 2.4W
- 12V = 2.4W

#### FT-270 LED with light control system – system CANBUS

- 12V = 0.4A
- 12V = 0.35A
- 12V = 0.4A
- 12V = 1.25A
- 12V = 0.35A
- 12V = 0.4A

- 12V = 5W
- 12V = 4W
- 12V = 5W
- 12V = 15W
- 12V = 4W
- 12V = 5W

#### BAYONET 5 PIN

Yellow / Żółty  
Plug view / Widok wtyczki



#### BAYONET 5 PIN

Green / Zielony  
Plug view / Widok wtyczki

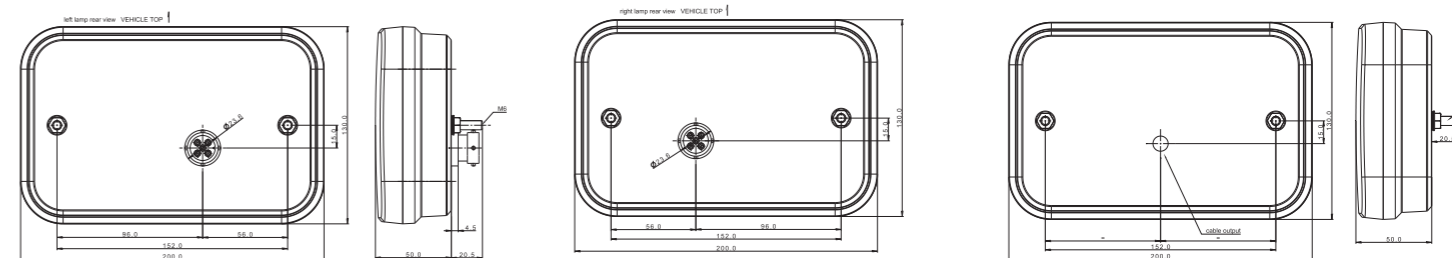

#### PRODUCTION:

FRISTOM  
Spółka z ograniczoną odpowiedzialnością i Sp. K.  
ul. Przemysłowa 5  
POLAND, 86-014 Sicienka

#### EXPORT:

mobile +48 609 909 456  
bstaniaszek@fristom.com.pl  
mobile +48 731 088 883  
wtomczak@fristom.com.pl

mobile +48 607 843 275  
rcardona@fristom.com.pl  
mobile +48 794 792 929  
mjanus@fristom.com.pl

Plug 7 Pins Innerwork / Wtyk 7 Pinów  
Plug view / Widok od wtyczki / ISO 1724

1	Left direction indicator / Kierunkowskaz lewy Yellow / Żółty
2	Fog / Światło przeciwmgłowe Blue / Niebieski
3	Ground / Uziemnienie White / Biały
4	Right direction indicator / Kierunkowskaz prawy Green / Zielony
5	Right position light / Światło pozycyjne prawe Brown / Brązowy
6	Stop light / Światło stop Red / Czerwony
7	Left position light / Światło pozycyjne lewe Black / Czarny

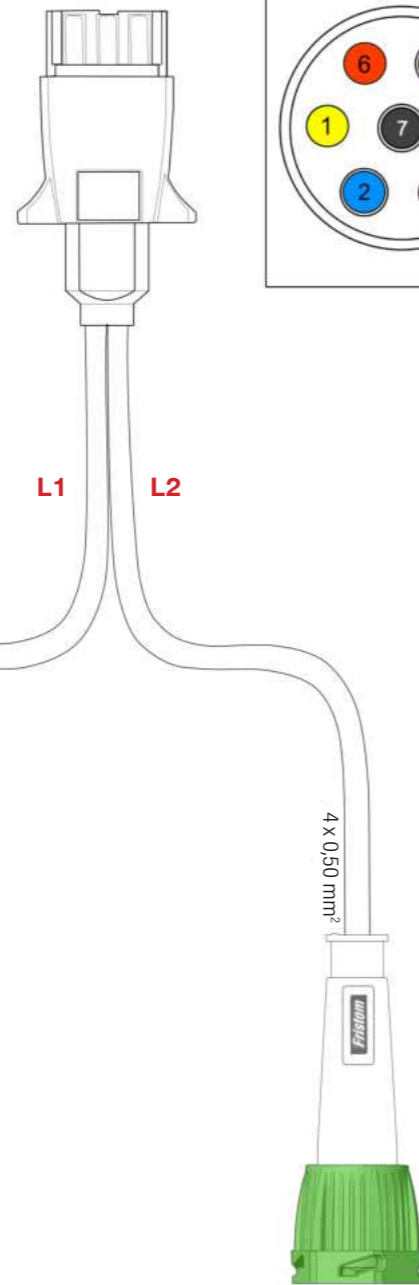

### 3-FUNCTIONAL LAMP:

STOP LIGHT  
REAR POSITION LIGHT  
INDICATOR



### 3-FUNCTIONAL LAMP:

STOP LIGHT  
REAR POSITION LIGHT  
INDICATOR



BAYONET 4 PIN  
Yellow / Żółty  
Plug view / Widok wtyczki

Direction indicator / Kierunkowskaz Yellow / Żółty	1	
Ground / Uziemnienie White / Biały	3	
Stop light / Światło stop Red / Czerwony	5	
Rear position light / Światło pozycyjne tylne Black / Czarny	7	

BAYONET 4 PIN  
Green / Zielony  
Plug view / Widok wtyczki

Ground / Uziemnienie White / Biały	3	
Direction indicator / Kierunkowskaz Green / Zielony	4	
Rear position light / Światło pozycyjne tylne Brown / Brązowy	5	
Stop light / Światło stop Red / Czerwony	6	

FT-122 LED

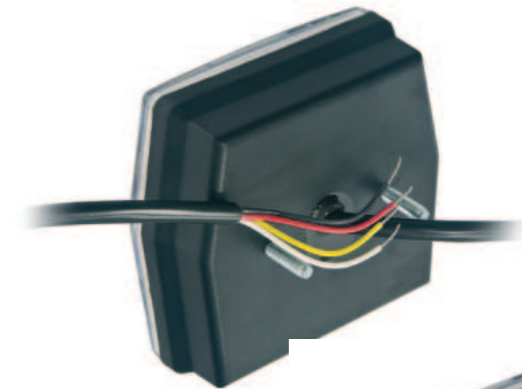

- 3-functional universal LED rear lamp – low power consumption
- european E9 homologation
- the lamp is homologated to be mounted horizontally and vertically as well
- ElectroMagnetic Compatibility – EMC certificate
- shock-resistance – PC lampshade
- reverse polarity protection system

#### Lamp functions:

- rear position light
- STOP light
- indicator

#### Technical specification:

- supply voltage: 12–36V DC
- operating temperature: -40°C to +55°C
- lamp is resistant to any weather conditions
- lamp is fully airtight

#### Power consumption:

- rear position light 12V/24V = 0.06A/0.06A
- STOP light 12V/24V = 0.08A/0.08A
- indicator 12V/24V = 0.08A/0.08A

#### Power consumption / Rated power:

- rear position light 12V/24V = 0.75W/1.5W
- STOP light 12V/24V = 1W/2W
- indicator 12V/24V = 1W/2W

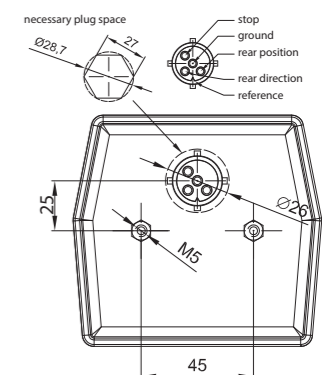
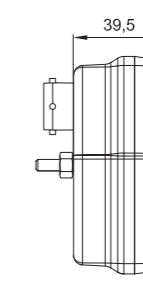
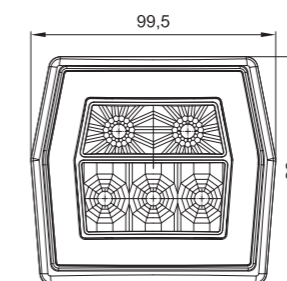
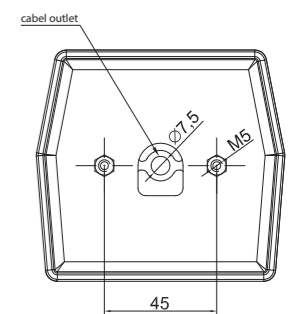
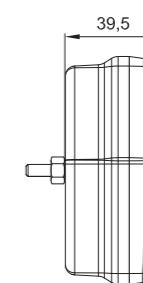
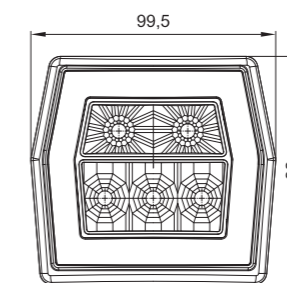

PRODUCTION:  
FRISTOM  
Spółka z ograniczoną odpowiedzialnością i Sp. K.  
ul. Przemysłowa 5  
POLAND, 86-014 Sicienka

EXPORT:  
mobile +48 609 909 456  
bstaniaszek@fristom.com.pl  
mobile +48 731 088 883  
wtomczak@fristom.com.pl

mobile +48 607 843 275  
rcardona@fristom.com.pl  
mobile +48 794 792 929  
mjanus@fristom.com.pl

Plug 7 Pins Innerwork / Wtyk 7 Pinów  
Plug view / Widok od wtyczki / ISO 1724

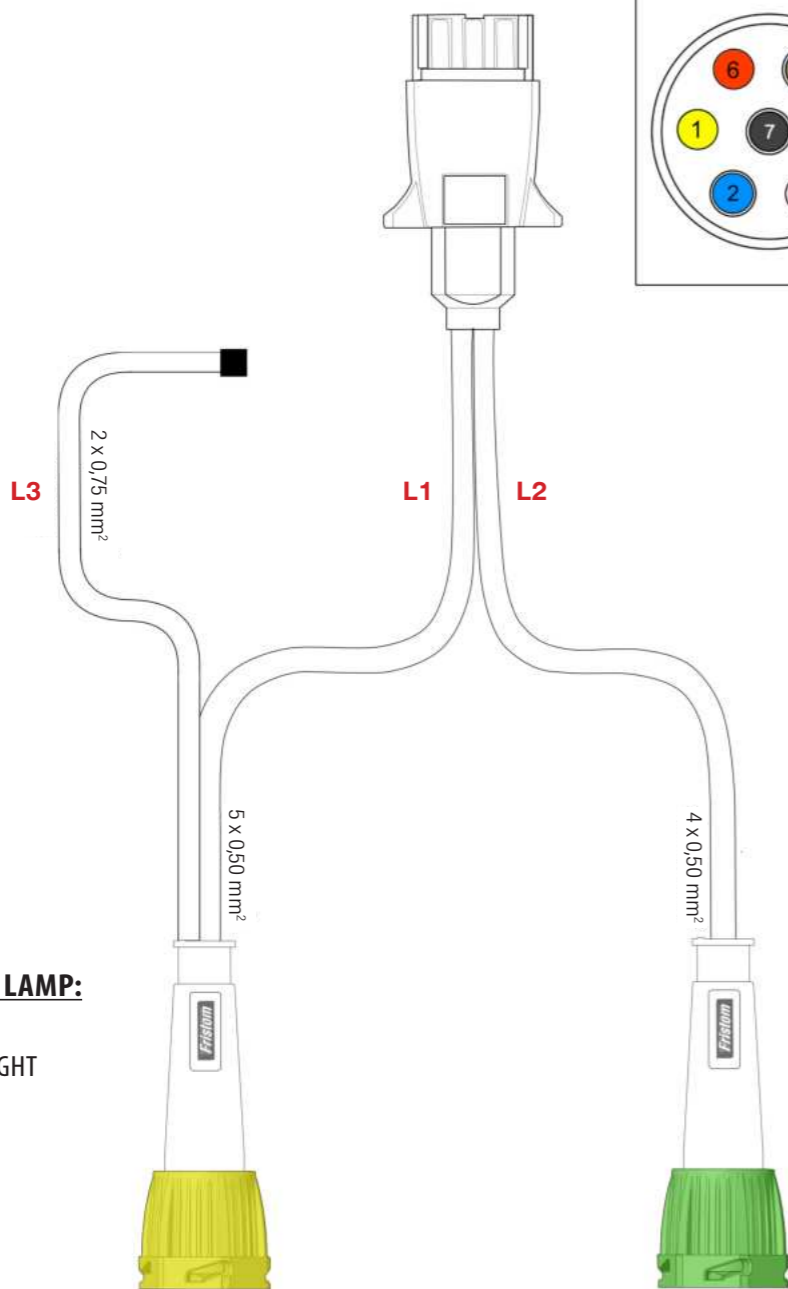
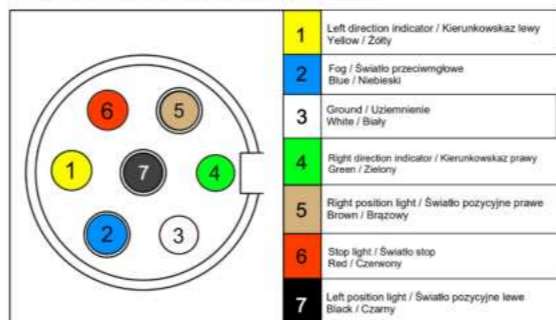

### 4-FUNCTIONAL LAMP:

- STOP LIGHT
- REAR POSITION LIGHT
- INDICATOR
- FOG LIGHT

### 3-FUNCTIONAL LAMP:

- STOP LIGHT
- REAR POSITION LIGHT
- INDICATOR

BAYONET 5 PIN  
Yellow / Żółty  
Plug view / Widok wtyczki



BAYONET 4 PIN  
Green / Zielony  
Plug view / Widok wtyczki

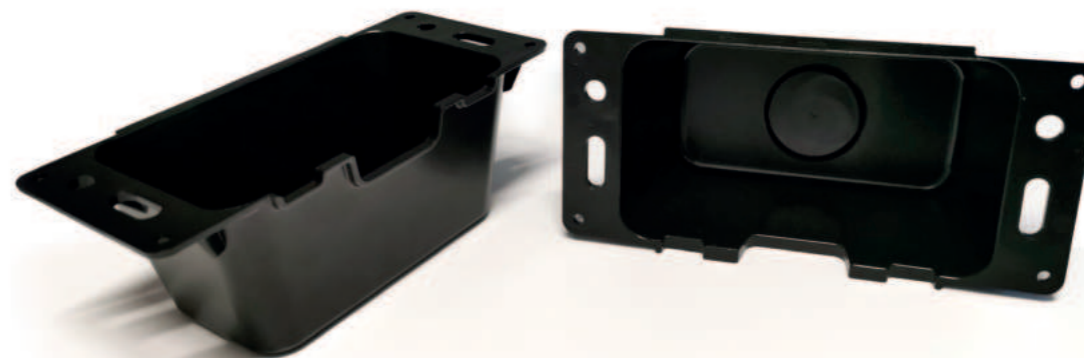

## Small LAMP COVER

The tail lamp cover is primarily used to protect the lamp's electrical connector with an electric bundle against harmful weather conditions such as: water, mud or road salt in winter conditions. The cover is made of high quality material, making it extremely durable.

### Application of this product:

- will significantly extend the life of the lamp connector
- it will allow you to hide the excess wire inside the cover.

It can be mounted with rear lamps with mounting bolt spacing 150–152mm.

For Fristom lamps with Bayonet or AMP connector you can list the following products:

FT-277 LED	FT-230 LED	FT-270 LED	FT-170 LED
FT-130 LED	FT-077	FT-088	FT-089

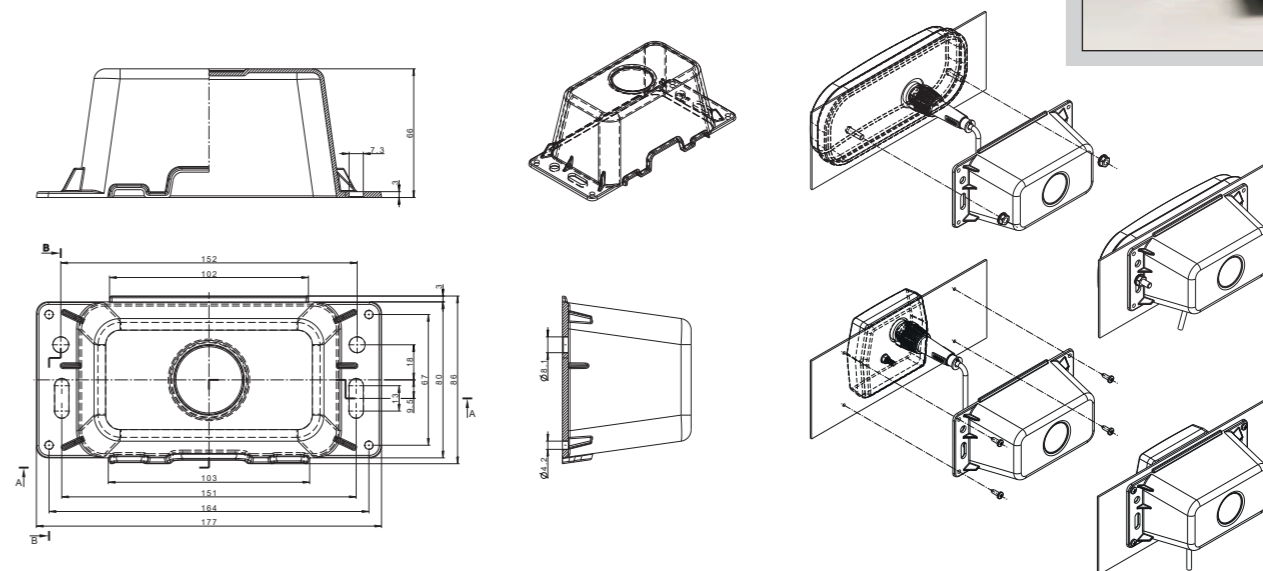

PRODUCTION:  
FRISTOM  
Spółka z ograniczoną odpowiedzialnością i Sp. K.  
ul. Przemysłowa 5  
POLAND, 86-014 Sicienka

EXPORT:  
mobile +48 609 909 456  
bstaniaszek@fristom.com.pl  
mobile +48 731 088 883  
wtomczak@fristom.com.pl

mobile +48 607 843 275  
rcardona@fristom.com.pl  
mobile +48 794 792 929  
mjanus@fristom.com.pl

Plug 7 Pins Innerwork / Wtyk 7 Pinów  
Plug view / Widok od wtyczki / ISO 1724

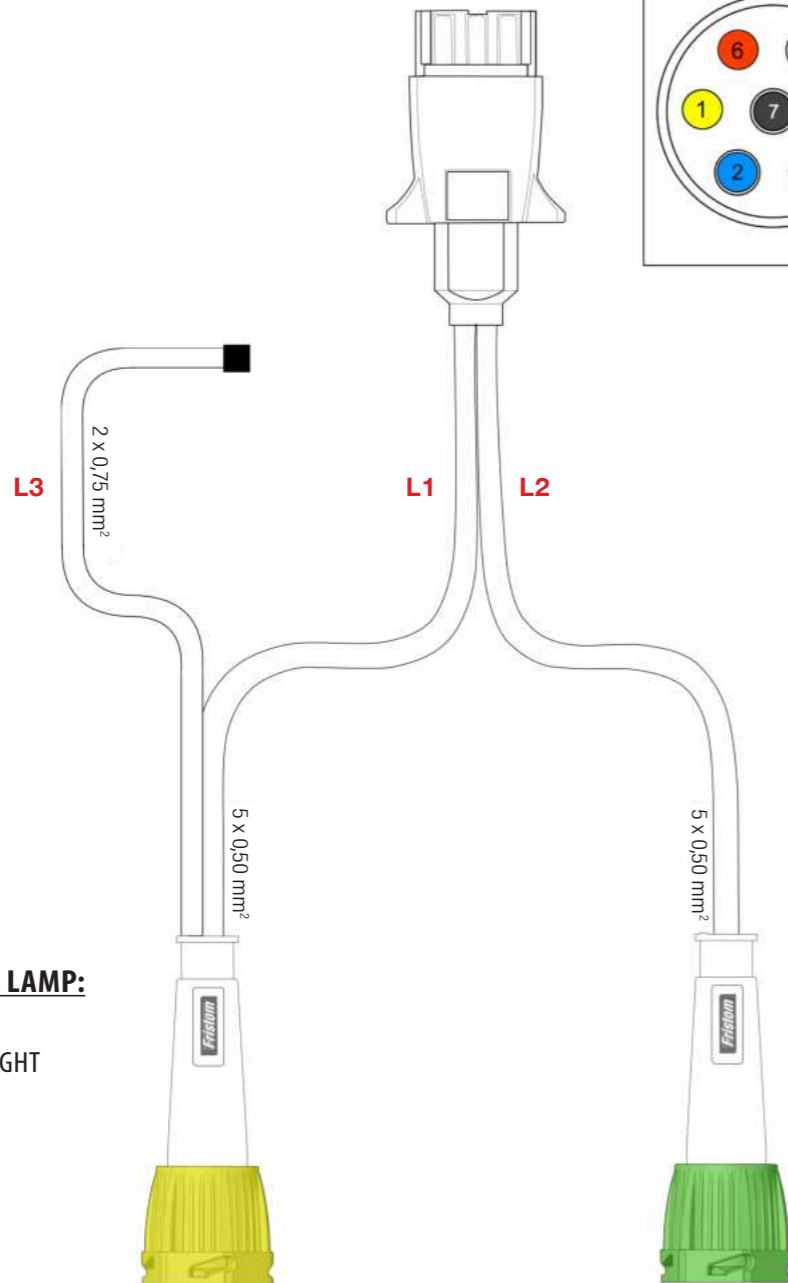
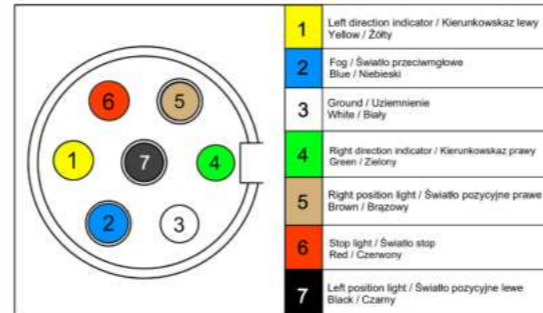

### 4-FUNCTIONAL LAMP:

STOP LIGHT  
REAR POSITION LIGHT  
INDICATOR  
FOG LIGHT

### 4-FUNCTIONAL LAMP:

STOP LIGHT  
REAR POSITION LIGHT  
INDICATOR  
FOG LIGHT

BAYONET 5 PIN  
Yellow / Żółty  
Plug view / Widok wtyczki



BAYONET 5 PIN  
Green / Zielony  
Plug view / Widok wtyczki



FT-230 PM LED DI



*dynamic indicator*

FT-230 LED



FT-230 COF LED DI

- 6-functional LED rear lamp - low power consumption
- European homologation E9
- ElectroMagnetic Compatibility (EMC) homologation R10
- shock-resistance - PC lampshade
- reverse polarity protection system

#### Lamp functions:

- rear running light
- number plate light homologated on an universal performance 34.4 mm <<X>> 102.2 mm; version NT - has no function of number plate light
- STOP light
- indicator
- reversing light (version COF), or fog light (version PM)
- reflector

#### Technical specification:

- supply voltage: 12-36V DC
- operating temperature: -40°C to +55°C
- lamp is resistant to any weather conditions
- lamp is fully airtight

#### Power consumption:

- rear running light + number plate light: 12V/24V = 0.12A/0.12A
- STOP light: 12V/24V = 0.12A/0.12A
- indicator: 12V/24V = 0.35A/0.35A
- reversing light: 12V/24V = 0.22A/0.22A
- fog light: 12V/24V = 0.16A/0.16A

#### Power consumption / Rated power:

- rear running light + number plate light: 12V/24V = 1.5W/3W
- STOP light: 12V/24V = 1.5W/3W
- indicator: 12V/24V = 4.5W/9W
- reversing light: 12V/24V = 2.8W/5.5W
- fog light: 12V/24V = 2W/4W

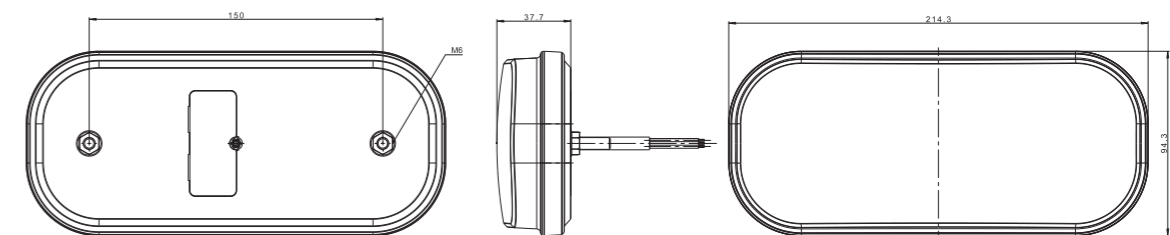
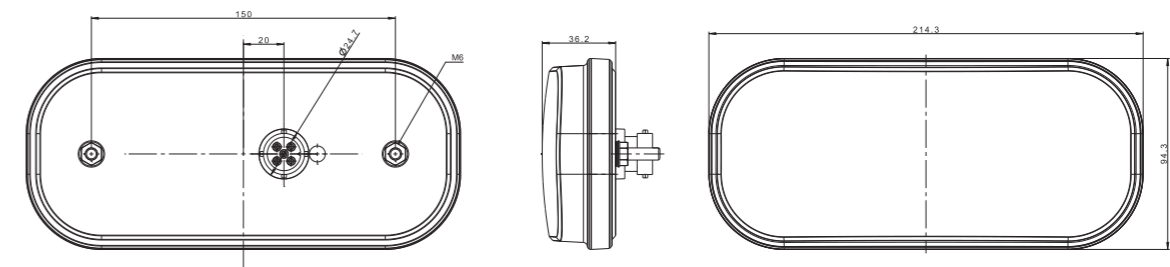

#### PRODUCTION:

FRISTOM  
Spółka z ograniczoną odpowiedzialnością i Sp. K.  
ul. Przemysłowa 5  
POLAND, 86-014 Sicienka

#### EXPORT:

mobile +48 609 909 456  
bstaniaszek@fristom.com.pl  
mobile +48 731 088 883  
wtomczak@fristom.com.pl

mobile +48 607 843 275  
rcardona@fristom.com.pl  
mobile +48 794 792 929  
mjanus@fristom.com.pl



Plug 7 Pins Innerwork / Wtyk 7 Pinów  
Plug view / Widok od wtyczki / ISO 1724

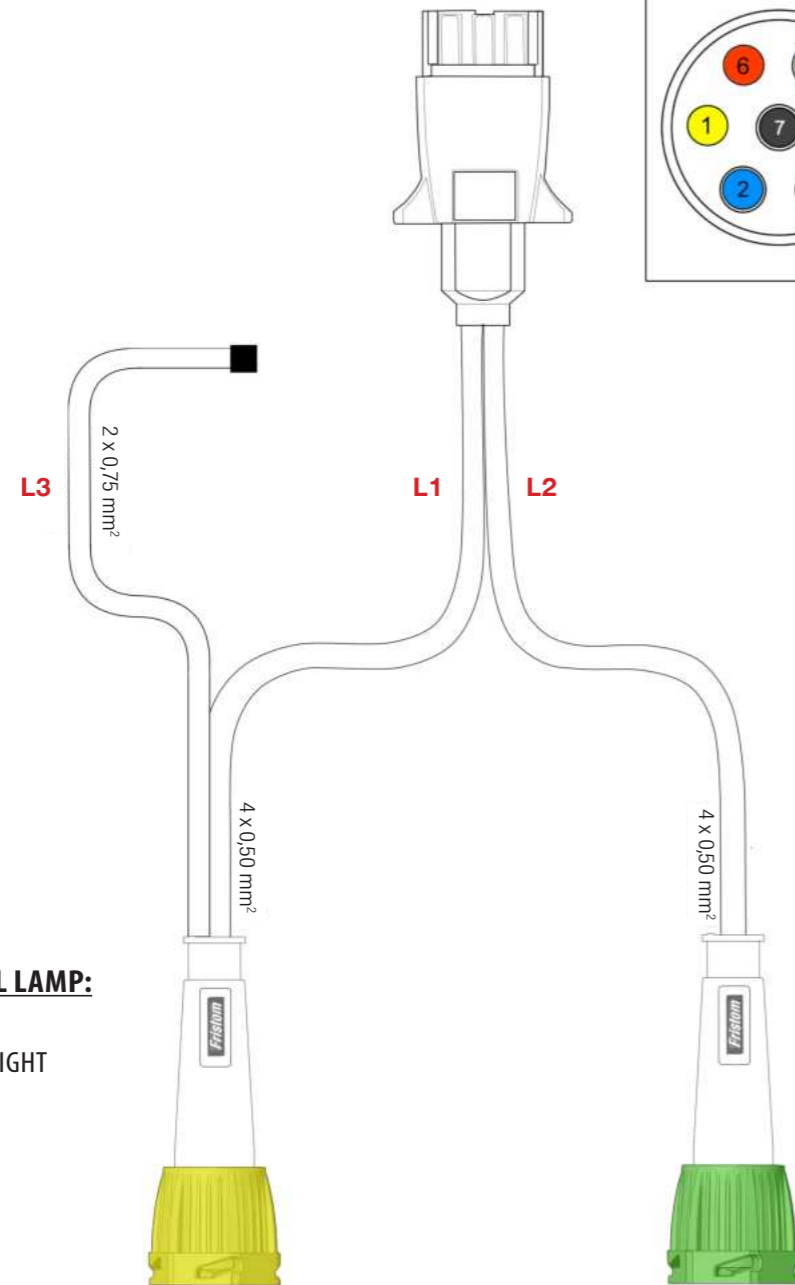
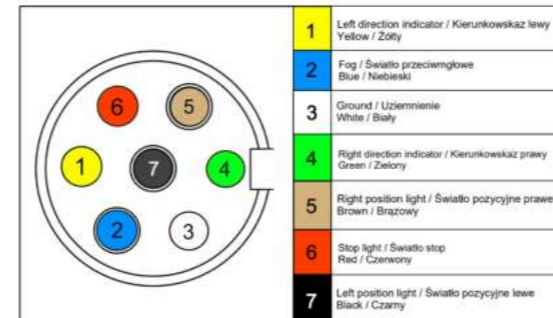

### 3-FUNCTIONAL LAMP:

STOP LIGHT  
REAR POSITION LIGHT  
INDICATOR

### 3-FUNCTIONAL LAMP:

STOP LIGHT  
REAR POSITION LIGHT  
INDICATOR

BAYONET 4 PIN  
Yellow / Żółty  
Plug view / Widok wtyczki



BAYONET 4 PIN  
Green / Zielony  
Plug view / Widok wtyczki



## 3-FUNCTIONAL UNIVERSAL LED REAR LAMP



FT-371 LED 12V



- European E9 homologation
- ElectroMagnetic Compatibility – EMC certificate
- Shock-resistance – PC lampshade
- Reverse polarity protection system

#### Lamp functions:

- rear position light
- STOP light
- indicator
- number plate light - bottom (depending on the version\*)
- reflector (triangle) kat. IIIA

#### Technical specification:

- supply voltage: 12-15V DC
- operating temperature: -40°C to +55°C
- lamp is resistant to any weather conditions
- lamp is fully airtight IP68

#### Power consumption:

- rear position light: 12V – 0.5A
- STOP light: 12V – 0.5A
- indicator: 12V – 1.2A

#### Power consumption / Rated power:

- rear position light: 12V – 6W
- STOP light: 12V – 6W
- indicator: 12V – 15W

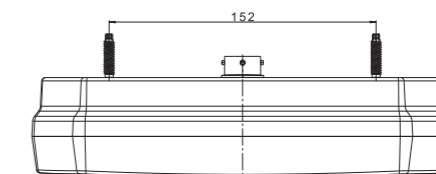
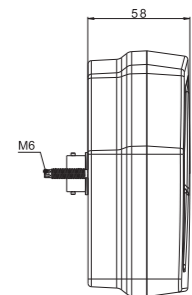
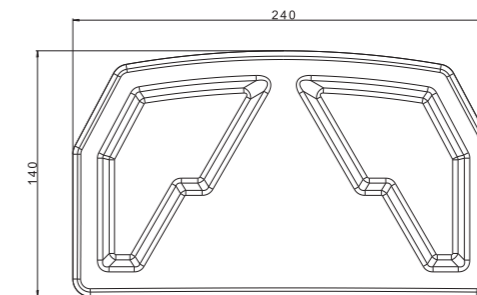

SYSTEM  
CANBUS

#### PRODUCTION:

FRISTOM  
Spółka z ograniczoną odpowiedzialnością i Sp. K.  
ul. Przemysłowa 5  
POLAND, 86-014 Sicienka

#### EXPORT:

mobile +48 609 909 456  
bstaniaszek@fristom.com.pl  
mobile +48 731 088 883  
wtomczak@fristom.com.pl

mobile +48 607 843 275  
rcardona@fristom.com.pl  
mobile +48 794 792 929  
mjanus@fristom.com.pl

Plug 7 Pins Innerwork / Wtyk 7 Pinów  
Plug view / Widok od wtyczki / ISO 1724

1	Left direction indicator / Kierunkowskaz lewy Yellow / Żółty
2	Fog / Światło przeciwmgłowe Blue / Niebieski
3	Ground / Uziemnienie White / Biały
4	Right direction indicator / Kierunkowskaz prawy Green / Zielony
5	Right position light / Światło pozycyjne prawe Brown / Brązowy
6	Stop light / Światło stop Red / Czerwony
7	Left position light / Światło pozycyjne lewe Black / Czarny

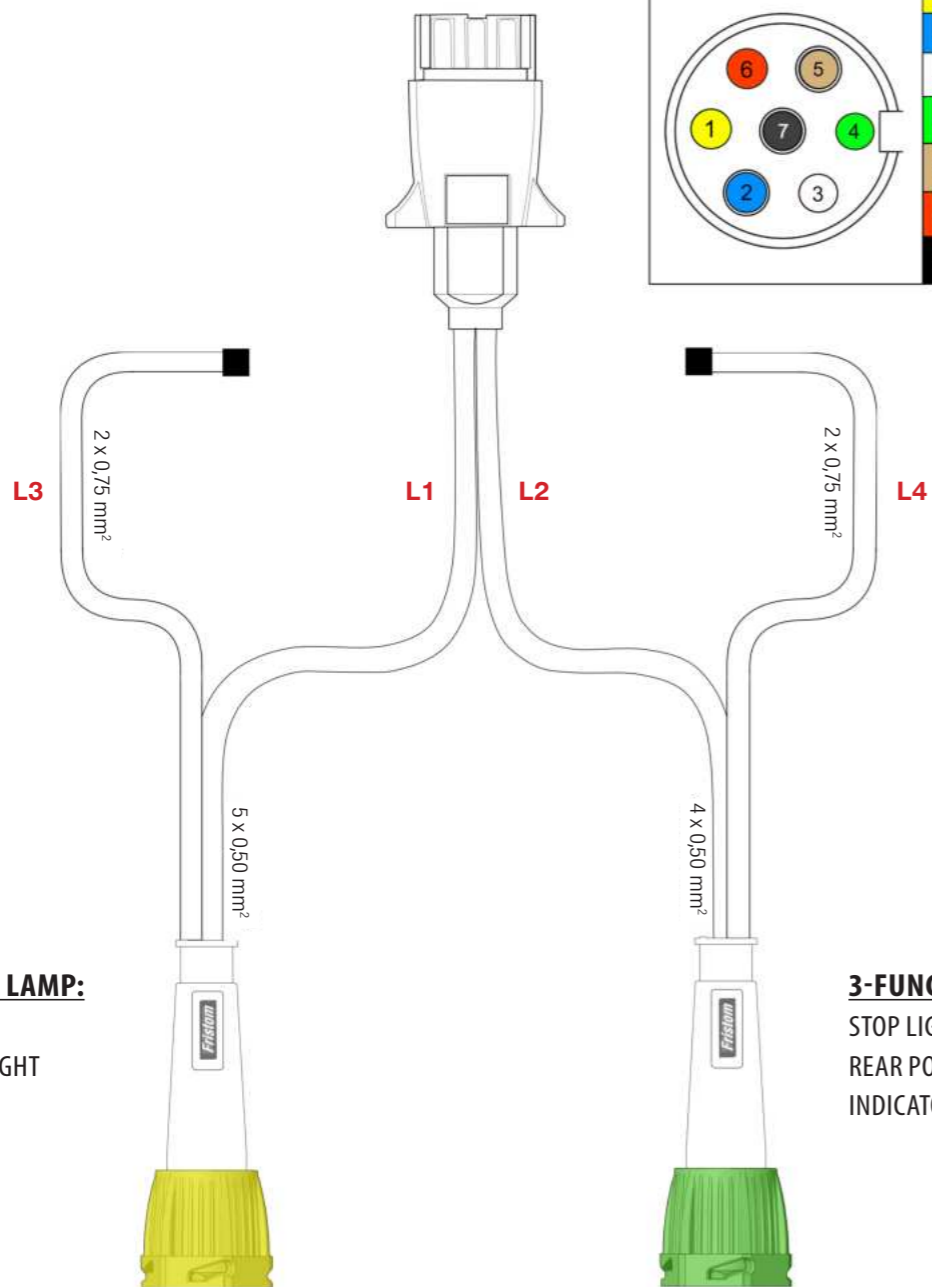

#### 4-FUNCTIONAL LAMP:

- STOP LIGHT
- REAR POSITION LIGHT
- INDICATOR
- FOG LIGHT

#### 3-FUNCTIONAL LAMP:

- STOP LIGHT
- REAR POSITION LIGHT
- INDICATOR

#### BAYONET 5 PIN

Yellow / Żółty  
Plug view / Widok wtyczki

Direction indicator / Kierunkowskaz Yellow / Żółty	1	
Fog / Światło przeciwmgłowe Blue / Niebieski	2	
Ground / Uziemnienie White / Biały	3	
Stop light / Światło stop Red / Czerwony	6	
Rear position light / Światło pozycyjne tylne Black / Czarny	7	

#### BAYONET 4 PIN

Green / Zielony  
Plug view / Widok wtyczki

Ground / Uziemnienie White / Biały	3	
Direction indicator / Kierunkowskaz Green / Zielony	4	
Rear position light / Światło pozycyjne tylne Brown / Brązowy	5	
Stop light / Światło stop Red / Czerwony	6	

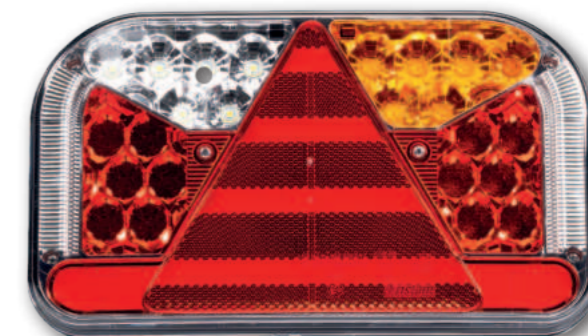
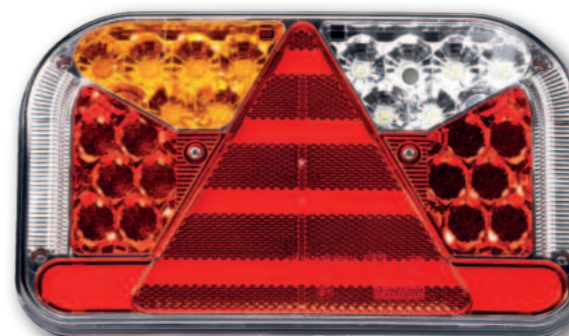

- 7-functional universal LED lamp – low power consumption
- european homologation E9
  - ElectroMagnetic Compatibility (EMC) homologation
  - shock-resistance – PC lampshade
  - reverse polarity protection system

#### Technical specification:

- rear running light
- number plate light
- STOP light
- indicator
- fog light
- reflector
- reversing light

#### Technical specification:

- supply voltage: 12–36V DC
- operating temperature: -40°C to +55°C
- lamp is resistant to any weather conditions
- lamp is fully airtight

#### Power consumption:

- rear running light + number plate light – 12V/ 24V = 0.25A/ 0.2A
- STOP light – 12V/ 24V = 0.08A/ 0.08A
- indicator – 12V/ 24V = 0.12A/ 0.12A
- reversing light – 12V/ 24V = 0.2A/ 0.1A
- fog light – 12V/ 24V = 0.15A/ 0.08A

#### Power consumption / Rated power:

- rear running light + number plate light – 12/ 24V = 3W/ 5W
- STOP light – 12V/ 24V = 1W/ 2W
- indicator – 12V/ 24V = 1.5W/ 3W
- reversing light – 12/ 24V = 2.5W/ 2.5W
- fog light – 12V/ 24V = 2W/ 2W

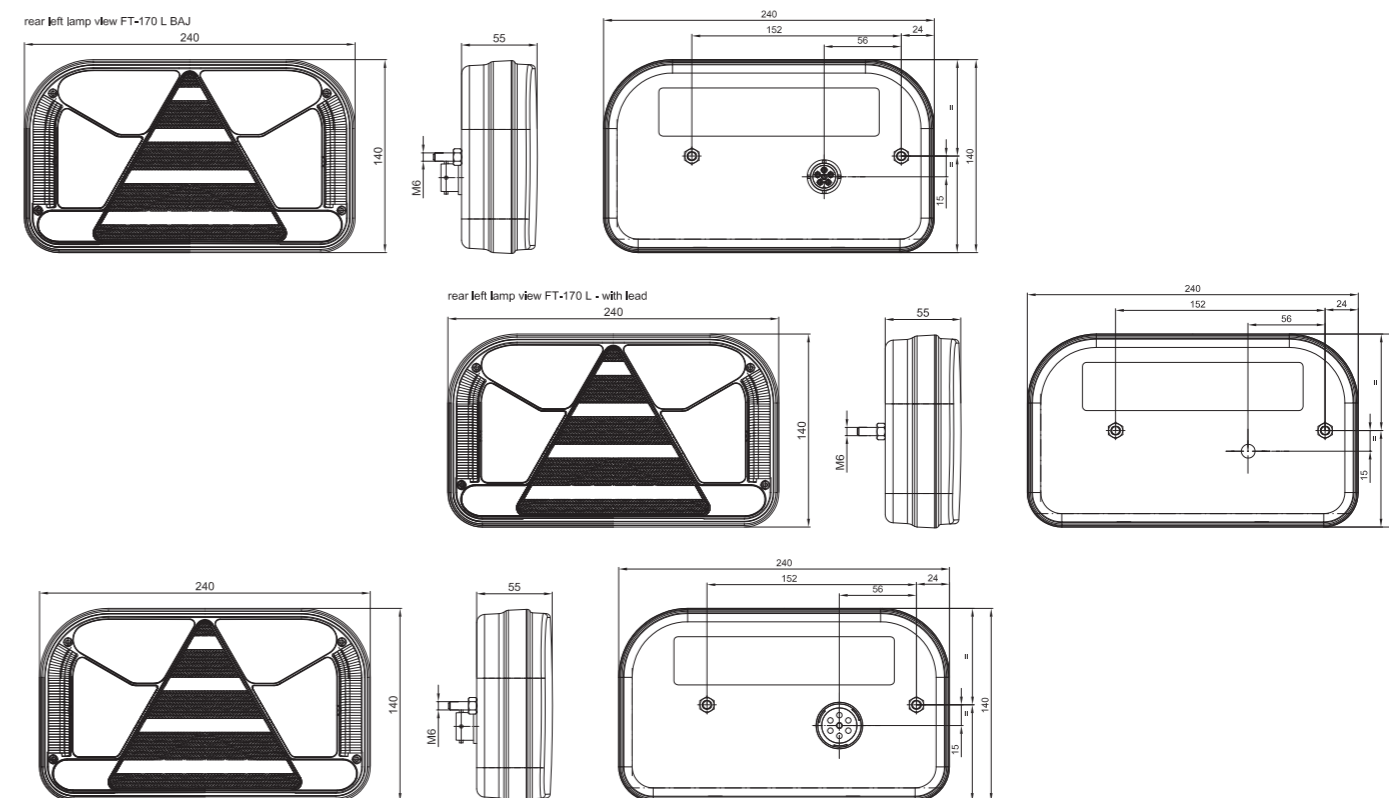

#### PRODUCTION:

FRISTOM  
Spółka z ograniczoną odpowiedzialnością i Sp. K.  
ul. Przemysłowa 5  
POLAND, 86-014 Sicienko

#### EXPORT:

mobile +48 609 909 456  
bstaniaszek@fristom.com.pl  
mobile +48 731 088 883  
wtomczak@fristom.com.pl

mobile +48 607 843 275  
rcardona@fristom.com.pl  
mobile +48 794 792 929  
mjanus@fristom.com.pl

Plug 7 Pins Innerwork / Wtyk 7 Pinów  
Plug view / Widok od wtyczki / ISO 1724

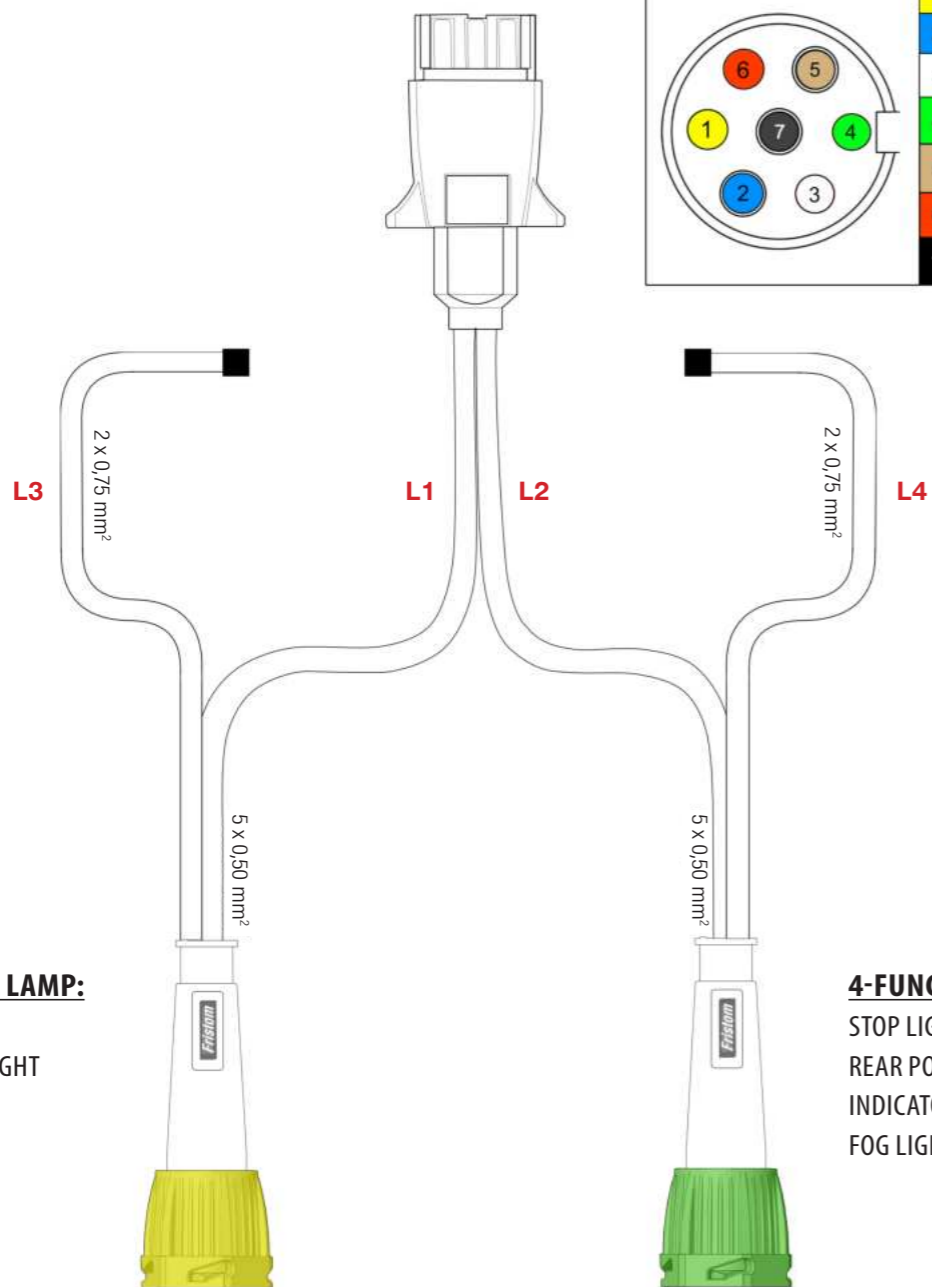
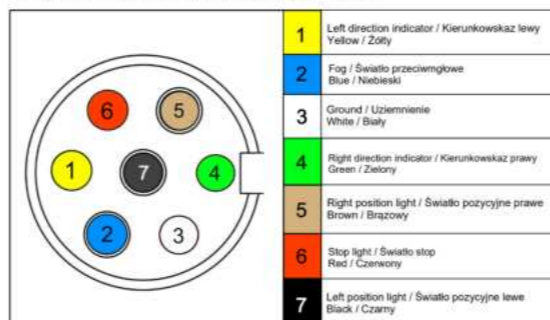

### 4-FUNCTIONAL LAMP:

- STOP LIGHT
- REAR POSITION LIGHT
- INDICATOR
- FOG LIGHT

### 4-FUNCTIONAL LAMP:

- STOP LIGHT
- REAR POSITION LIGHT
- INDICATOR
- FOG LIGHT

### BAYONET 5 PIN

Yellow / Żółty  
Plug view / Widok wtyczki



### BAYONET 5 PIN

Green / Zielony  
Plug view / Widok wtyczki



FT-130 LED



- 6-functional universal LED rear lamp - low power consumption
- European homologation E9
- ElectroMagnetic Compatibility (EMC) homologation
- Shock-resistance - PC lampshade
- Reverse polarity protection system

### Lamp functions:

- rear running light
- number plate light homologated on an universal performance 34,4 mm <<X>> 102,2 mm
- STOP light
- indicator
- fog light (FT-130 PM LED) or reversing (FT-130 COF LED) light (depending on the product version)
- reflector

### Technical specification:

- supply voltage: 12-36V DC
- operating temperature: -40°C to +55°C
- lamp is resistant to any weather conditions
- lamp is fully airtight

### Power consumption:

- rear running light + number plate light - 12V/24V = 0.25/0.21A
- STOP light - 12V/24V = 0.08A/0.08A
- indicator - 12V/24V = 0.11A/0.11A
- fog light - 12V/24V = 0.12A/0.6A
- reversing light - 12V/24V = 0.28A/0.14A

### Power consumption / Rated power:

- rear running light + number plate light - 12/24V = 3W/5W
- STOP light - 12V/24V = 1W/2W
- indicator - 12V/24V = 1.5W/3W
- fog light - 12V/24V = 1.5W/1.5W
- reversing light - 12/24V = 3.5W/3.5W

FT-130 COF BAJONET

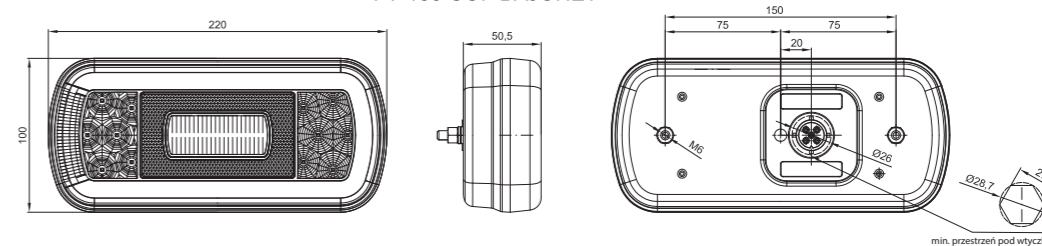

FT-130 COF

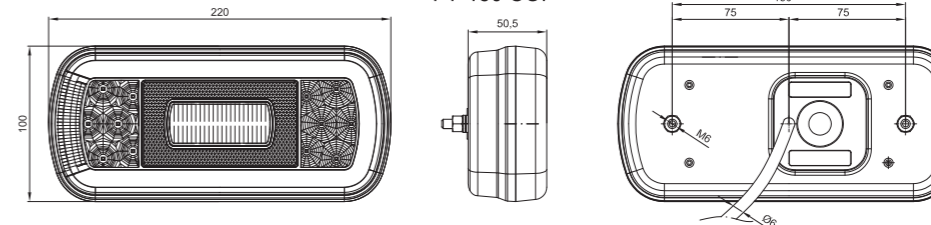

FT-130 PM

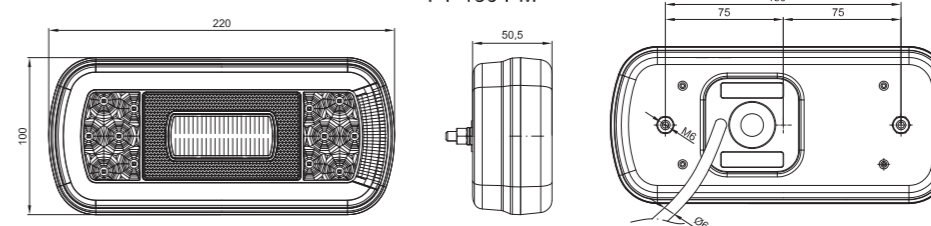

### PRODUCTION:

FRISTOM  
Spółka z ograniczoną odpowiedzialnością i Sp. K.  
ul. Przemysłowa 5  
POLAND, 86-014 Sicienka

### EXPORT:

mobile +48 609 909 456  
bstaniaszek@fristom.com.pl  
mobile +48 731 088 883  
wtomczak@fristom.com.pl

mobile +48 607 843 275  
rcardona@fristom.com.pl  
mobile +48 794 792 929  
mjanus@fristom.com.pl

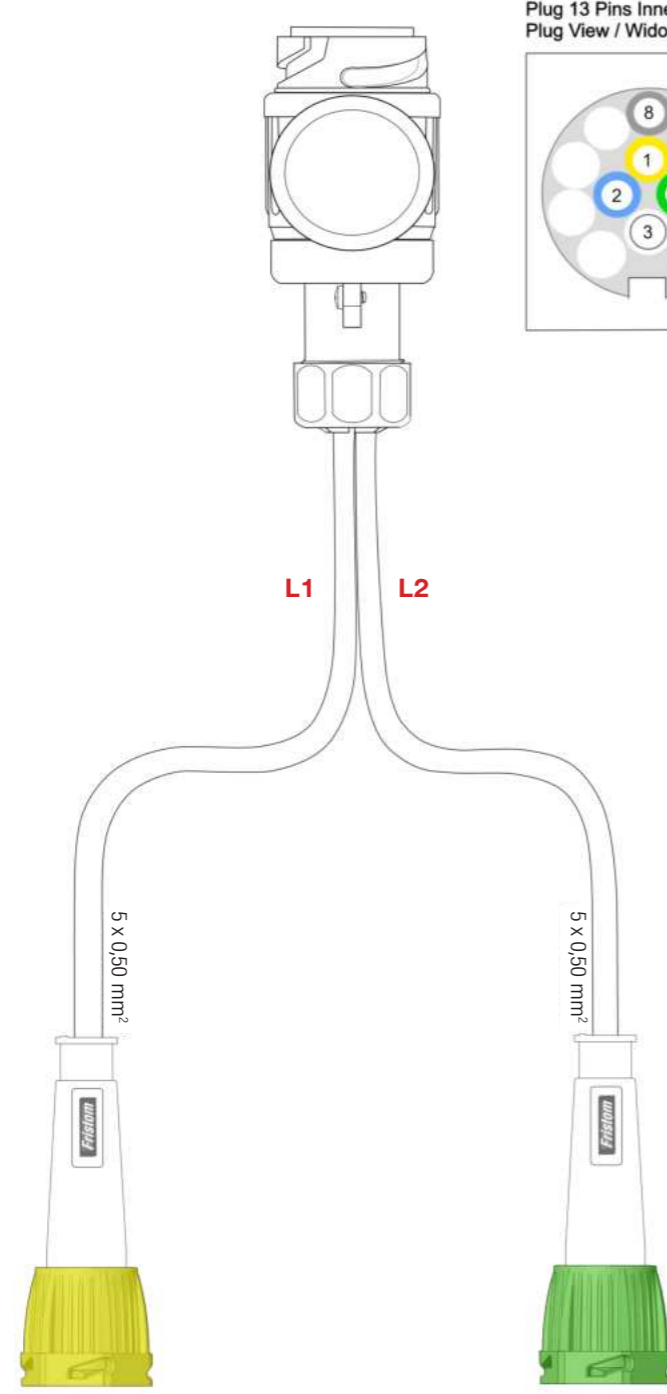
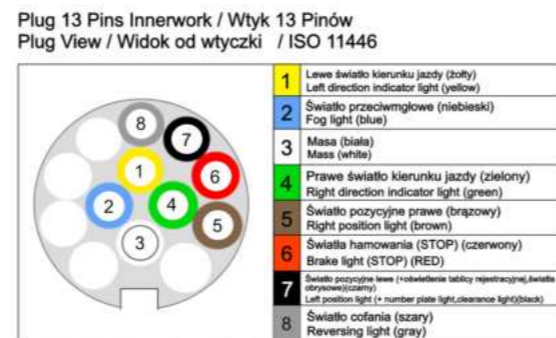

### 4-FUNCTIONAL LAMP:

- STOP LIGHT
- REAR POSITION LIGHT
- INDICATOR
- FOG LIGHT

### 4-FUNCTIONAL LAMP:

- STOP LIGHT
- REAR POSITION LIGHT
- INDICATOR
- REVERSING LIGHT

### BAYONET 5 PIN Yellow / Żółty Plug view / Widok wtyczki



### BAYONET 5 PIN Green / Zielony Plug view / Widok wtyczki



## FT-277 LED

# ONE lamp, TWO faces!

A NEW LAMP available with LIGHT CONTROL SYSTEM.



Universal LED lamp – low power consumption  
European homologation E9  
ElectroMagnetic Compatibility (EMC) homologate on  
shock-resistance – PC lampshade  
reverse polarity protection system

#### Lamp functions:

- rear running light
- STOP light
- indicator
- reversing light
- fog light
- reflector

#### Technical specification:

- supply voltage: 12–15V DC
- operating temperature: -40°C to +55°C
- lamp is resistant to any weather conditions

#### Power consumption:

- rear running light
- STOP light:
- indicator:
- reversing light:
- fog light:

#### Power consumption / Rated power:

- rear running light
- STOP light:
- indicator:
- reversing light:
- fog light:

#### FT-270 LED

- 12V = 0.1A
- 12V = 0.3A
- 12V = 0.35A
- 12V = 0.25A
- 12V = 0.35A

- 12V = 1.2W
- 12V = 3.6W
- 12V = 4.2W
- 12V = 3W
- 12V = 4.2W

#### FT-270 LED

with light control system  
– system CANBUS

- 12V = 0.4A
- 12V = 0.4A
- 12V = 1.25A
- 12V = 0.35A
- 12V = 0.4A

- 12V = 5W
- 12V = 5W
- 12V = 15W
- 12V = 4W
- 12V = 5W

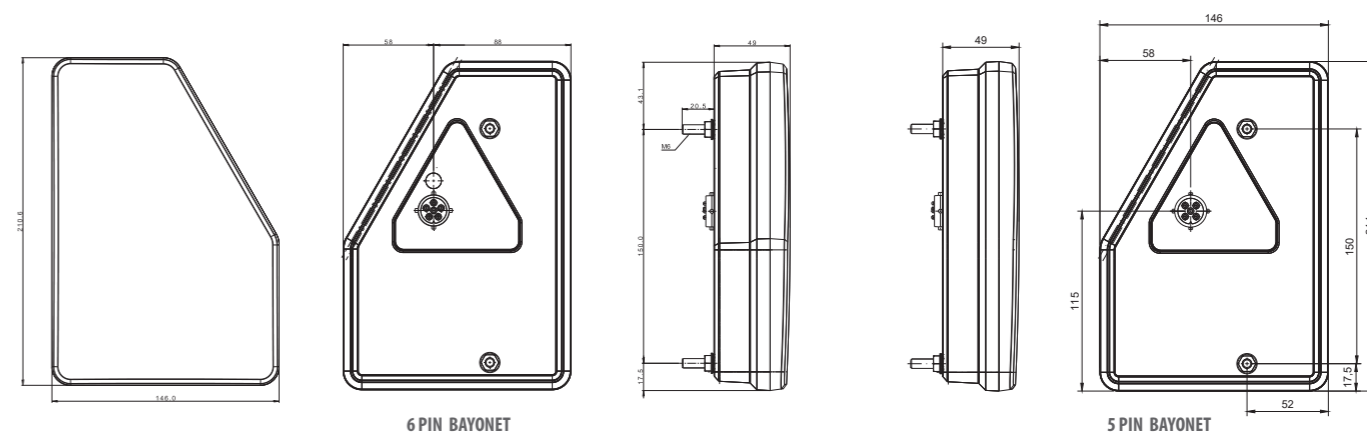

6 PIN BAYONET

5 PIN BAYONET

#### PRODUCTION:

FRISTOM  
Spółka z ograniczoną odpowiedzialnością i Sp. K.  
ul. Przemysłowa 5  
POLAND, 86-014 Sicienko

#### EXPORT:

mobile +48 609 909 456  
bstaniaszek@fristom.com.pl  
mobile +48 731 088 883  
wtomczak@fristom.com.pl

mobile +48 607 843 275  
rcardona@fristom.com.pl  
mobile +48 794 792 929  
mjanus@fristom.com.pl

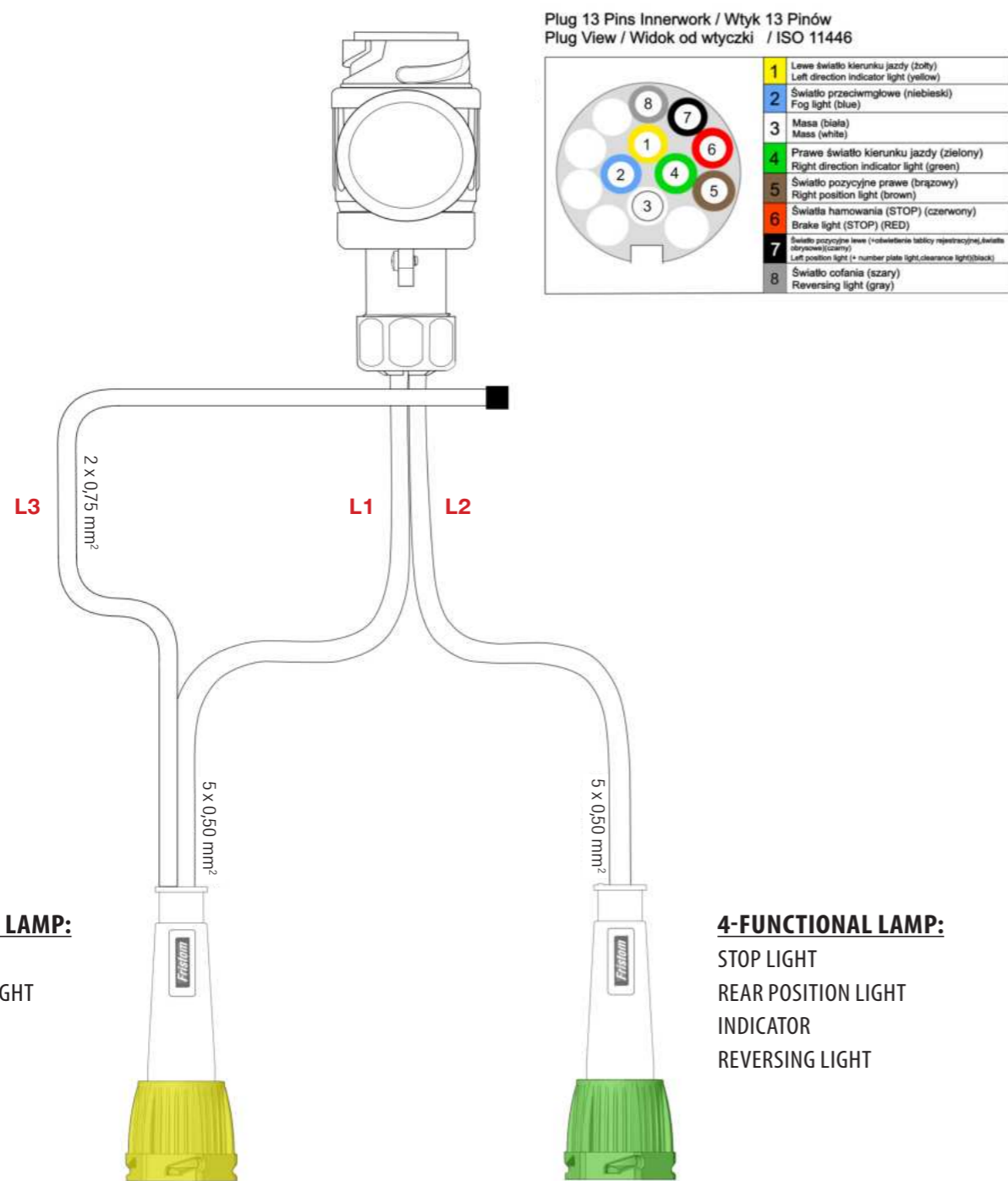

Plug 13 Pins Innerwork / Wtyk 13 Pinów  
Plug View / Widok od wtyczki / ISO 11446

1	Lewe światło kierunku jazdy (żółty) Left direction indicator light (yellow)
2	Światło przeciwmgłowe (niebieski) Fog light (blue)
3	Masa (biała) Mass (white)
4	Prawe światło kierunku jazdy (zielony) Right direction indicator light (green)
5	Światło pozycyjne prawe (brązowy) Right position light (brown)
6	Światła hamowania (STOP) (czerwony) Brake light (STOP) (RED)
7	Światło pozycyjne lewe (robociznik tablicy rejestracyjnej, światła obrzynowe) (szary) Left position light (+ number plate light/clearance light)(black)
8	Światło cofania (szary) Reversing light (gray)

### 4-FUNCTIONAL LAMP:

- STOP LIGHT
- REAR POSITION LIGHT
- INDICATOR
- FOG LIGHT

### 4-FUNCTIONAL LAMP:

- STOP LIGHT
- REAR POSITION LIGHT
- INDICATOR
- REVERSING LIGHT

### BAYONET 5 PIN Yellow / Żółty Plug view / Widok wtyczki

Direction indicator / Kierunkowskaz Yellow / Żółty	1
Fog / Światło przeciwmgłowe Blue / Niebieski	2
Ground / Uziemnienie White / Biały	3
Stop light / Światło stop Red / Czerwony	6
Rear position light / Światło pozycyjne tylne Black / Czarny	7

### BAYONET 5 PIN Green / Zielony Plug view / Widok wtyczki

Ground / Uziemnienie White / Biały	3
Direction indicator / Kierunkowskaz Green / Zielony	4
Rear position light / Światło pozycyjne tylne Brown / Brązowy	5
Stop light / Światło stop Red / Czerwony	6
Reversing light / Światło cofania Gray / Szary	8

## FT-213 LED

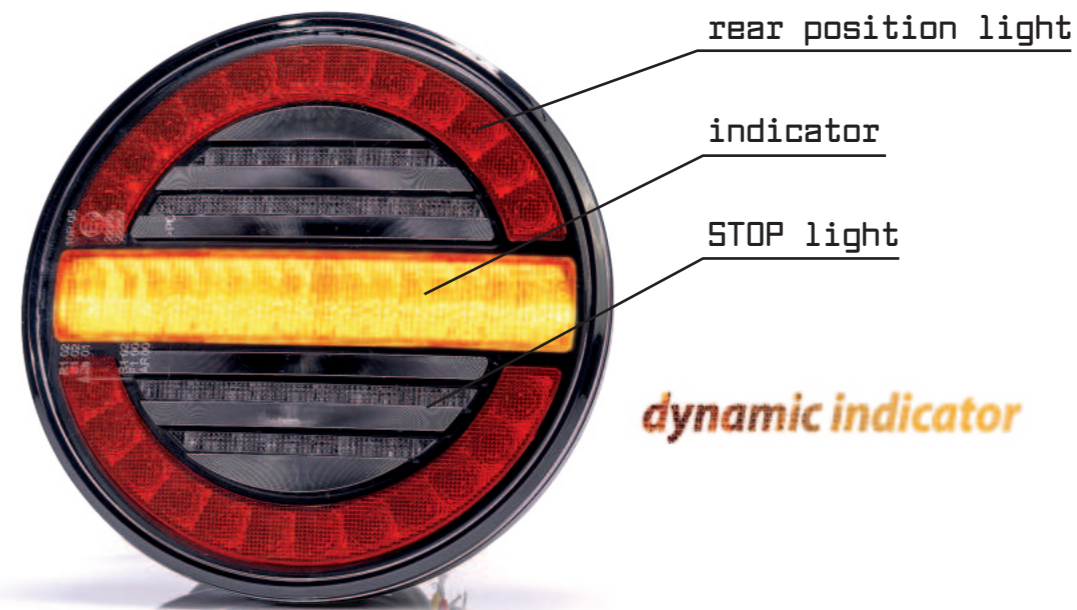

3-functional universal LED rear lamp – low power consumption  
European E9 homologation  
ElectroMagnetic Compatibility – EMC certificate  
Shock-resistance – PC lampshade  
Reverse polarity protection system  
The lamp depth is only 35 mm  
**Dynamic indicator**  
**Crystal-like position light**

In the lamp it has been used an **innovative** position light that **imitates microcrystals**. This solution creates the **illusion of living light**, even while looking at the lamp from different angles.

**Lamp functions:**  
- rear position light  
- STOP light  
- indicator

**Technical specification:**  
- supply voltage: 12–36V DC  
- operating temperature: –40°C to +55°C  
- lamp is resistant to any weather conditions  
- lamp is **fully airtight**  
- cable out 1 m

**Power consumption:**  
- rear position light : 12V/24V = 0.05A/0.05A  
- STOP light: 12V/24V = 0.2A/0.2A  
- indicator: 12V/24V = 0.35A/0.35A

**Power consumption / Rated power:**  
- rear position light : 12V/24V = 0.6W/1.2W  
- STOP light: 12V/24V = 2.5W/5W  
- indicator: 12V/24V = 4.5W/9W

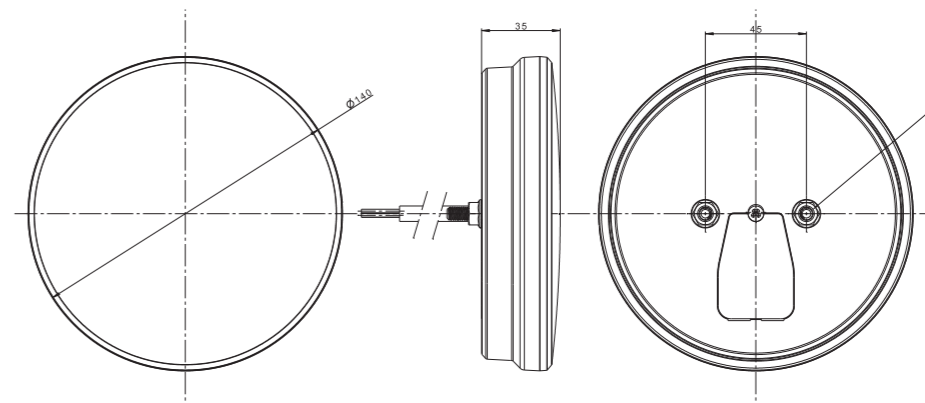

**PRODUCTION:**  
FRISTOM  
Spółka z ograniczoną odpowiedzialnością i Sp. K.  
ul. Przemysłowa 5  
POLAND, 86-014 Sicienka

**EXPORT:**  
mobile +48 609 909 456  
bstaniaszek@fristom.com.pl  
mobile +48 731 088 883  
wtomczak@fristom.com.pl

mobile +48 607 843 275  
rcardona@fristom.com.pl  
mobile +48 794 792 929  
mjanus@fristom.com.pl

Plug 13 Pins Innerwork / Wtyk 13 Pinów  
Plug View / Widok od wtyczki / ISO 11446

1	Lewe światło kierunku jazdy (żółty) Left direction indicator light (yellow)
2	Światło przeciwmgłowe (niebieski) Fog light (blue)
3	Masa (biała) Mass (white)
4	Prawe światło kierunku jazdy (zielony) Right direction indicator light (green)
5	Światło pozycyjne prawe (brązowy) Right position light (brown)
6	Światła hamowania (STOP) (czerwony) Brake light (STOP) (RED)
7	Światło pozycyjne lewe (+obrotowe światło kierunkowskaz, światło czarne/szary) Left position light (= number plate light, clearance light/black)
8	Światło cofania (szary) Reversing light (gray)

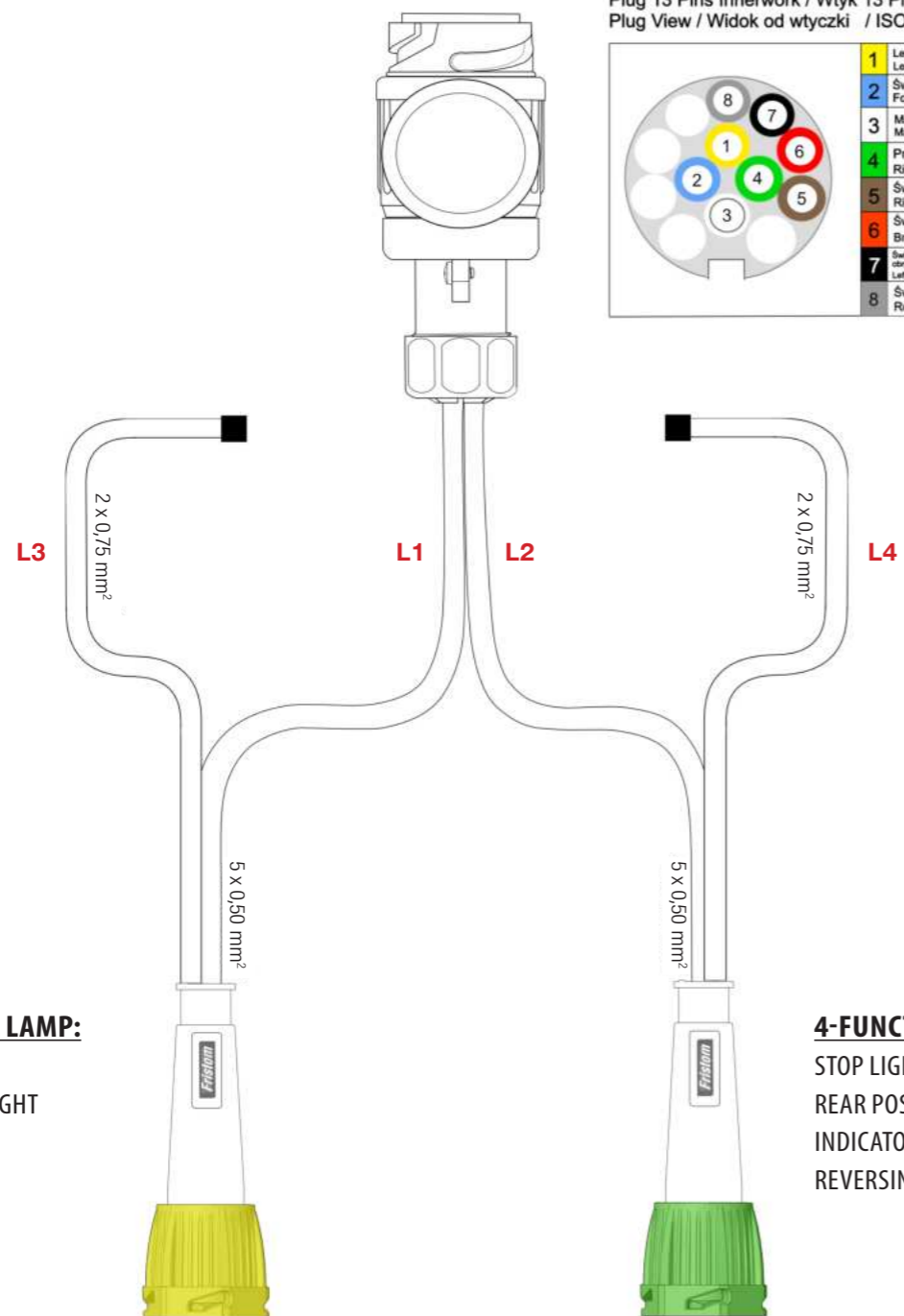

### 4-FUNCTIONAL LAMP:

STOP LIGHT  
REAR POSITION LIGHT  
INDICATOR  
FOG LIGHT

### 4-FUNCTIONAL LAMP:

STOP LIGHT  
REAR POSITION LIGHT  
INDICATOR  
REVERSING LIGHT

BAYONET 5 PIN  
Yellow / Żółty  
Plug view / Widok wtyczki

Direction indicator / Kierunkowskaz Yellow / Żółty	1
Fog / Światło przeciwmgłowe Blue / Niebieski	2
Ground / Uziemnienie White / Biały	3
Stop light / Światło stop Red / Czerwony	6
Rear position light / Światło pozycyjne tylne Black / Czarny	7

BAYONET 5 PIN  
Green / Zielony  
Plug view / Widok wtyczki

Ground / Uziemnienie White / Biały	3
Direction indicator / Kierunkowskaz Green / Zielony	4
Rear position light / Światło pozycyjne tylne Brown / Brązowy	5
Stop light / Światło stop Red / Czerwony	6
Reversing light / Światło cofania Gray / Szary	8

FT-017 LED



FT-072 LED



FT-061 LED



FT-069 LED



FT-009 LED



FT-140 LED

PRODUCTION:  
FRISTOM  
Spółka z ograniczoną odpowiedzialnością i Sp. K.  
ul. Przemysłowa 5  
POLAND, 86-014 Sicienka

EXPORT:  
mobile +48 609 909 456  
bstaniaszek@fristom.com.pl  
mobile +48 731 088 883  
wtomczak@fristom.com.pl

mobile +48 607 843 275  
rcardona@fristom.com.pl  
mobile +48 794 792 929  
mjanus@fristom.com.pl

### dynamic indicator

### FT-600 LED

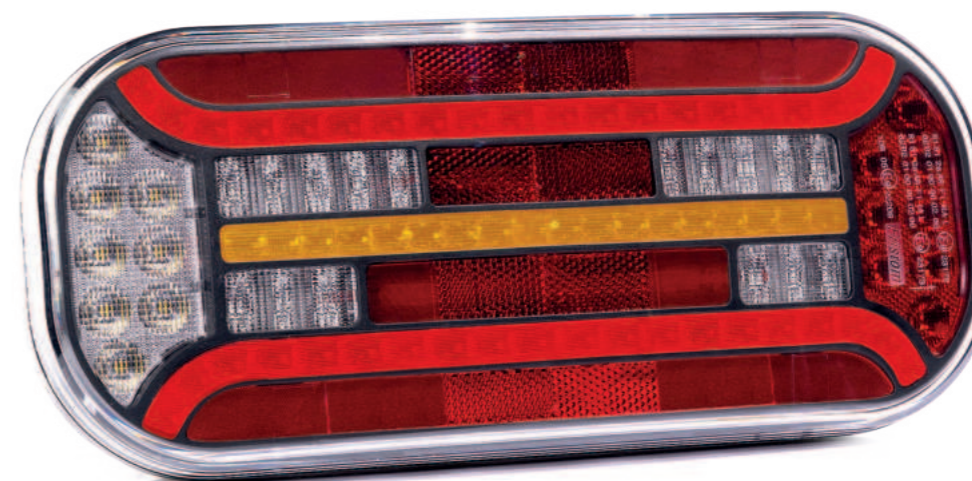

FT-600 LED  
(version for vehicle)

#### INTELLIGENT STOP LIGHT

As a new trend on the market the lamp uses intelligent STOP light technology. When the fog light is on, the STOP function beams partly to meet requirements for approval.

7-functional universal LED lamp – low power consumption  
European homologation E9  
ElectroMagnetic Compatibility (EMC) homologation  
Shock-resistance – PC lampshade  
Reverse polarity protection system

#### Lamp functions:

- rear running light
- number plate light (bottom)
- STOP light
- indicator
- reversing light
- fog light
- reflector

#### Technical specification:

- supply voltage: 12–36V DC
- operating temperature: –40°C do +55°C
- lamp is resistant to any weather conditions
- lamp is fully airtight

#### Power consumption:

- rear running light + number plate light: 12V/24V = 0.2A/0.2A
- STOP light: 12V/24V = 0.3A/0.3A
- indicator: 12V/24V = 0.85A/0.85A
- reversing light: 12V/24V = 0.2A/0.25A
- fog light: 12V/24V = 0.15A/0.15A

#### Power consumption / Rated power:

- rear running light + number plate light: 12V/24V = 2.5W/5W
- STOP light: 12V/24V = 4W/8W
- indicator: 12V/24V = 10W/20W
- reversing light: 12V/24V = 2.5W/6W
- fog light: 12V/24V = 2W/4W

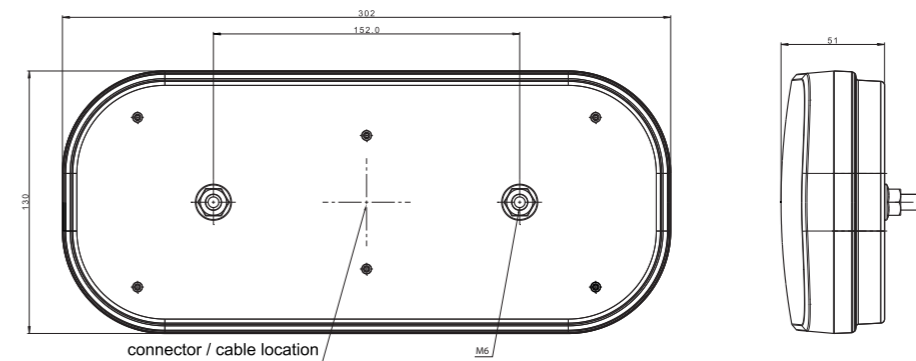

Plug 13 Pins Innerwork / Wtyk 13 Pinów  
Plug View / Widok od wtyczki / ISO 11446

1	Lewe światło kierunku jazdy (żółty) Left direction indicator light (yellow)
2	Światło przeciwmglowe (niebieski) Fog light (blue)
3	Masa (biała) Mass (white)
4	Prawe światło kierunku jazdy (zielony) Right direction indicator light (green)
5	Światło pozycyjne prawe (brązowy) Right position light (brown)
6	Światła hamowania (STOP) (czerwony) Brake light (STOP) (RED)
7	Światło pozycyjne lewe (+oświetlenie tablicy rejestracyjnej, światła obrotowe/czarne) Left position light (+ number plate light, clearance light)(black)
8	Światło cofania (szary) Reversing light (gray)

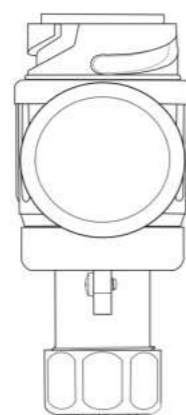

L1 L2

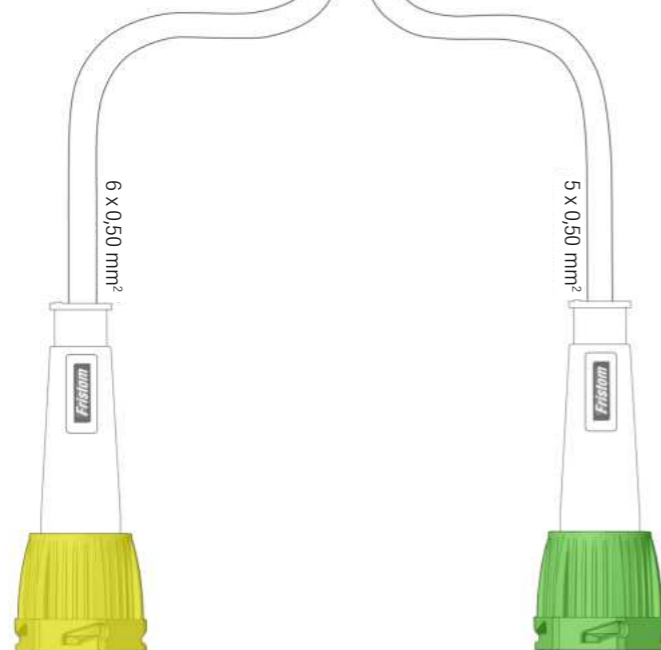

#### 5-FUNCTIONAL LAMP:

- STOP LIGHT
- REAR POSITION LIGHT
- INDICATOR
- FOG LIGHT
- REVERSING LIGHT

#### 4-FUNCTIONAL LAMP:

- STOP LIGHT
- REAR POSITION LIGHT
- INDICATOR
- REVERSING LIGHT

BAJONET 6 PIN  
Yellow / Żółty  
Plug view / Widok wtyczki

Direction indicator / Kierunkowskaz Yellow / Żółty	1
Fog / Światło przeciwmglowe Blue / Niebieski	2
Ground / Uziemnienie White / Biały	3
Stop light / Światło stop Red / Czerwony	4
Rear position light / Światło pozycyjne tylne Black / Czarny	5
Reversing light / Światło cofania Gray / Szary	6

BAJONET 5 PIN  
Green / Zielony  
Plug view / Widok wtyczki

Ground / Uziemnienie White / Biały	3
Direction indicator / Kierunkowskaz Green / Zielony	4
Rear position light / Światło pozycyjne tylne Brown / Brązowy	5
Stop light / Światło stop Red / Czerwony	6
Reversing light / Światło cofania Gray / Szary	8

#### PRODUCTION:

FRISTOM  
Spółka z ograniczoną odpowiedzialnością i Sp. K.  
ul. Przemysłowa 5  
POLAND, 86-014 Sicienko

#### EXPORT:

mobile +48 609 909 456  
bstaniaszek@fristom.com.pl  
mobile +48 731 088 883  
wtomczak@fristom.com.pl

mobile +48 607 843 275  
rcardona@fristom.com.pl  
mobile +48 794 792 929  
mjanus@fristom.com.pl

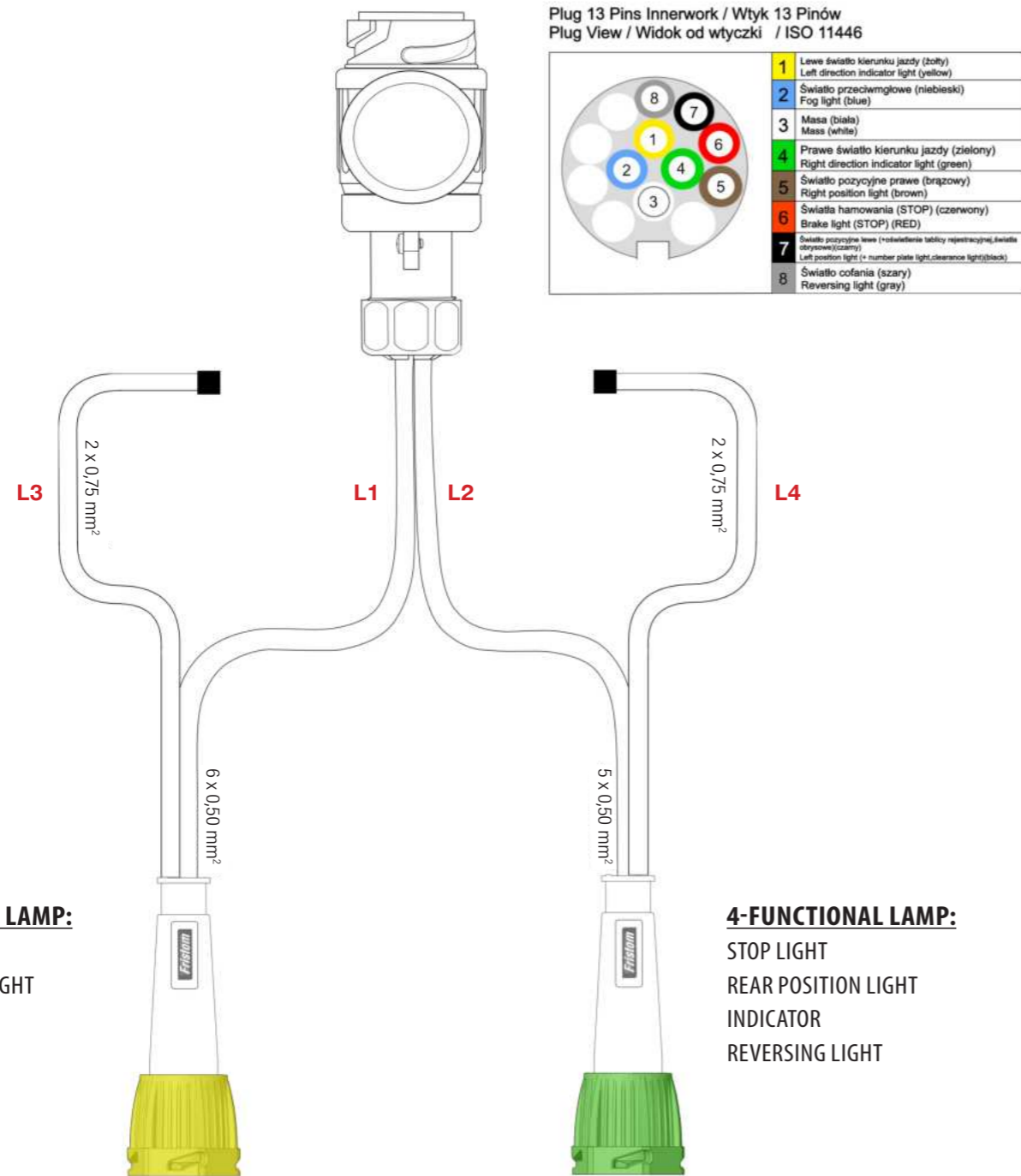

**BAJONET 6 PIN**  
Yellow / Żółty  
Plug view / Widok wtyczki

Direction indicator / Kierunkowskaz Yellow / Żółty	1
Fog / Światło przeciwmgłowe Blue / Niebieski	2
Ground / Uziemnienie White / Biały	3
Stop light / Światło stop Red / Czerwony	6
Rear position light / Światło pozycyjne tylne Black / Czarny	7
Reversing light / Światło cofania Gray / Szary	8

**BAJONET 5 PIN**  
Green / Zielony  
Plug view / Widok wtyczki

Ground / Uziemnienie White / Biały	3
Direction indicator / Kierunkowskaz Green / Zielony	4
Rear position light / Światło pozycyjne tylne Brown / Brązowy	5
Stop light / Światło stop Red / Czerwony	6
Reversing light / Światło cofania Gray / Szary	8

### dynamic indicator

### FT-610 LED

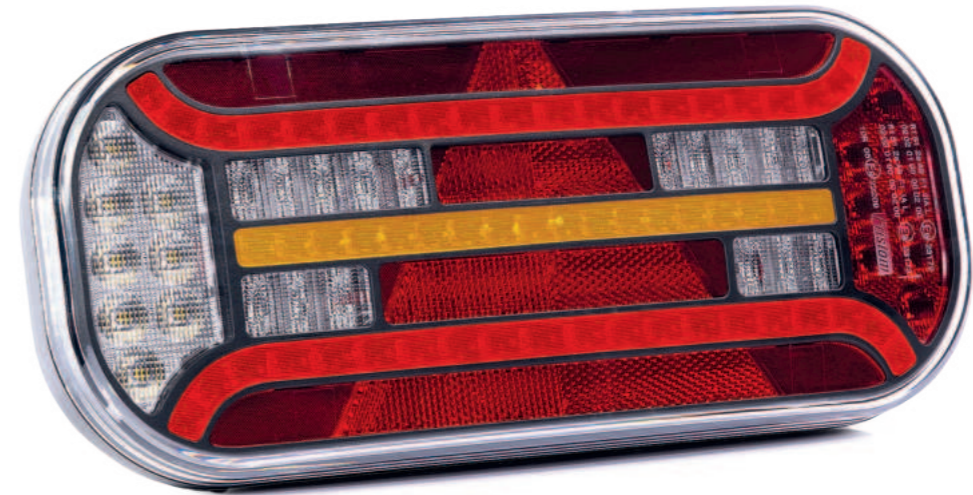

**FT-610 LED**  
(version for trailer)

- 7-functional universal LED lamp – low power consumption
- European homologation E9
- ElectroMagnetic Compatibility (EMC) homologation
- Shock-resistance – PC lampshade
- Reverse polarity protection system

**Lamp functions:**

- rear running light
- number plate light (bottom)
- STOP light
- indicator
- reversing light
- fog light
- reflector

**Technical specification:**

- supply voltage: 12–36V DC
- operating temperature: –40°C do +55°C
- lamp is resistant to any weather conditions
- lamp is fully airtight

**Power consumption:**

- rear running light + number plate light: 12V/24V = 0.2A/0.2A
- STOP light: 12V/24V = 0.3A/0.3A
- indicator: 12V/24V = 0.85A/0.85A
- reversing light: 12V/24V = 0.2A/0.25A
- fog light: 12V/24V = 0.15A/0.15A

**Power consumption / Rated power:**

- rear running light + number plate light: 12V/24V = 2.5W/5W
- STOP light: 12V/24V = 4W/8W
- indicator: 12V/24V = 10W/20W
- reversing light: 12V/24V = 2.5W/6W
- fog light: 12V/24V = 2W/4W

**INTELLIGENT STOP LIGHT**

As a new trend on the market the lamp uses intelligent STOP light technology. When the fog light is on, the STOP function beams partly to meet requirements for approval.

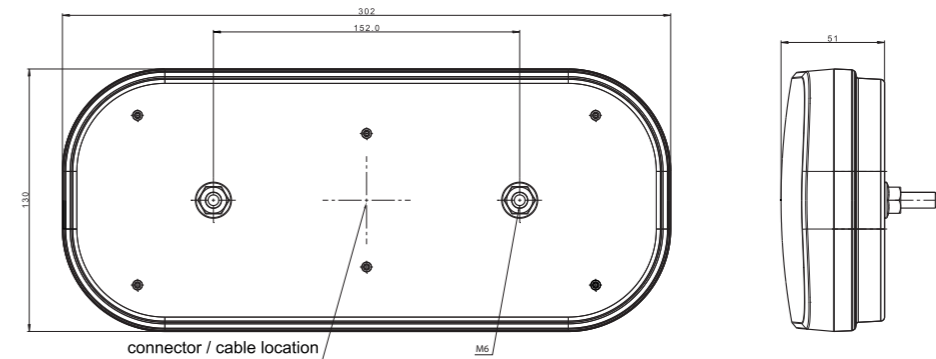

**PRODUCTION:**  
FRISTOM  
Spółka z ograniczoną odpowiedzialnością i Sp. K.  
ul. Przemysłowa 5  
POLAND, 86-014 Sicienka

**EXPORT:**  
mobile +48 609 909 456  
bstaniaszek@fristom.com.pl  
mobile +48 731 088 883  
wtomczak@fristom.com.pl

mobile +48 607 843 275  
rcardona@fristom.com.pl  
mobile +48 794 792 929  
mjanus@fristom.com.pl



FT-372 LED

7-functional LED lamp

### Lamp FUNCTIONS:

- rear running light
- number plate light
- STOP light
- indicator
- fog light
- reflector
- reversing light



IP 69

#### Power consumption:

- rear running light + number plate light: 12V/24V = 0.25A / 0.15A
- STOP light: 12V/24V = 0.15A / 0.08A
- indicator: 12V/24V = 0.2A / 0.1A
- reversing light: 12V/24V = 0.2A / 0.1A
- fog light: 12V/24V = 0.2A / 0.1A
- version without number plate light: 12V/24V = 0.2A / 0.1A

#### Power consumption / Rated power:

- rear running light + number plate light: 12V/24V = 3W / 3.6W
- STOP light: 12V/24V = 2W / 2W
- indicator: 12V/24V = 2.4W / 2.4W
- reversing light: 12V/24V = 2.4W / 2.4W
- fog light: 12V/24V = 2.4W / 2.4W
- version without number plate light: 12V/24V = 2.4W / 2.4W

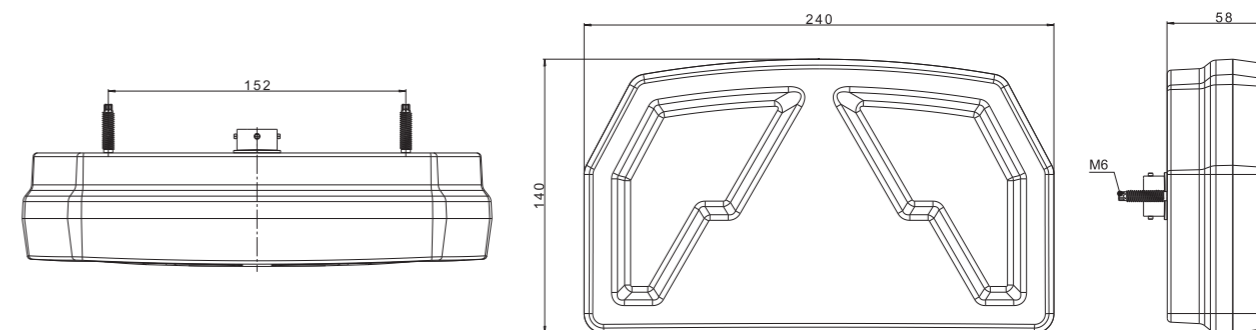

Plug 13 Pins Innerwork / Wtyk 13 Pinów  
Plug View / Widok od wtyczki / ISO 11446

1	Lewe światło kierunku jazdy (żółty) Left direction indicator light (yellow)
2	Światło przeciwmgłowe (niebieski) Fog light (blue)
3	Masa (biała) Mass (white)
4	Prawe światło kierunku jazdy (zielony) Right direction indicator light (green)
5	Światło pozycyjne prawe (brązowy) Right position light (brown)
6	Światła hamowania (STOP) (czerwony) Brake light (STOP) (RED)
7	Światło pozycyjne lewe (+oświetlenie tablicy rejestracyjnej, białe) Left position light (+ number plate light, clearance light)(black)
8	Światło cofania (szary) Reversing light (gray)

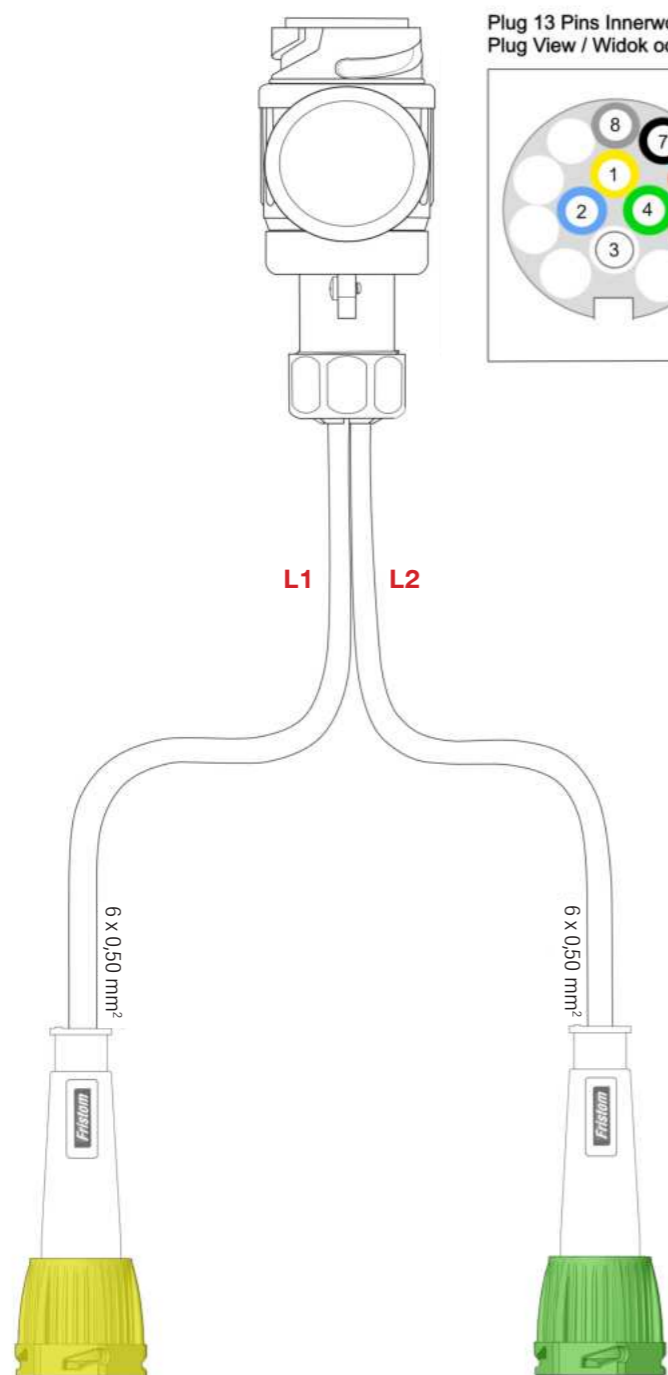

#### 5-FUNCTIONAL LAMP:

- STOP LIGHT
- REAR POSITION LIGHT
- INDICATOR
- FOG LIGHT
- REVERSING LIGHT

#### 5-FUNCTIONAL LAMP:

- STOP LIGHT
- REAR POSITION LIGHT
- INDICATOR
- FOG LIGHT
- REVERSING LIGHT

BAJONET 6 PIN  
Yellow / Żółty  
Plug view / Widok wtyczki

Direction indicator / Kierunkowskaz Yellow / Żółty	1
Fog / Światło przeciwmgłowe Blue / Niebieski	2
Ground / Uziemnienie White / Biały	3
Stop light / Światło stop Red / Czerwony	6
Rear position light / Światło pozycyjne tylne Black / Czarny	7
Reversing light / Światło cofania Gray / Szary	8

BAJONET 6 PIN  
Green / Zielony  
Plug view / Widok wtyczki

Fog / Światło przeciwmgłowe Blue / Niebieski	2
Ground / Uziemnienie White / Biały	3
Direction indicator / Kierunkowskaz Green / Zielony	4
Rear position light / Światło pozycyjne tylne Brown / Brązowy	5
Stop light / Światło stop Red / Czerwony	6
Reversing light / Światło cofania Gray / Szary	8

PRODUCTION:  
FRISTOM  
Spółka z ograniczoną odpowiedzialnością i Sp. K.  
ul. Przemysłowa 5  
POLAND, 86-014 Sicienka

EXPORT:  
mobile +48 609 909 456  
bstaniaszek@fristom.com.pl  
mobile +48 731 088 883  
wtomczak@fristom.com.pl

mobile +48 607 843 275  
rcardona@fristom.com.pl  
mobile +48 794 792 929  
mjanus@fristom.com.pl

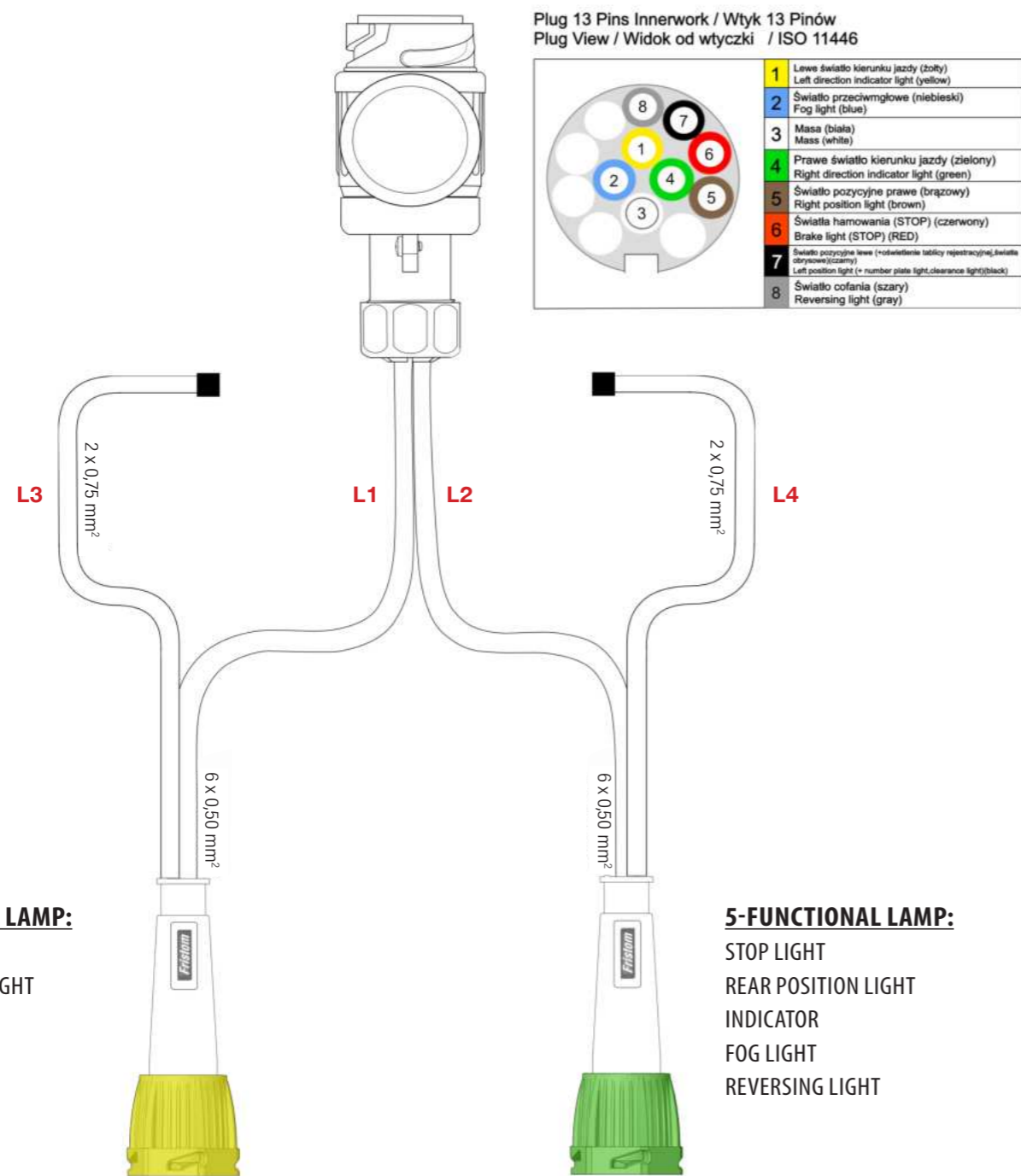

### 5-FUNCTIONAL LAMP:

- STOP LIGHT
- REAR POSITION LIGHT
- INDICATOR
- FOG LIGHT
- REVERSING LIGHT

### 5-FUNCTIONAL LAMP:

- STOP LIGHT
- REAR POSITION LIGHT
- INDICATOR
- FOG LIGHT
- REVERSING LIGHT

### BAJONET 6 PIN

**Yellow / Żółty**  
**Plug view / Widok wtyczki**

Direction indicator / Kierunkowskaz Yellow / Żółty	1
Fog / Światło przeciwmgłowe Blue / Niebieski	2
Ground / Uziemnienie White / Biały	3
Stop light / Światło stop Red / Czerwony	6
Rear position light / Światło pozycyjne tylne Black / Czarny	7
Reversing light / Światło cofania Gray / Szary	8

### BAJONET 6 PIN

**Green / Zielony**  
**Plug view / Widok wtyczki**

Fog / Światło przeciwmgłowe Blue / Niebieski	2
Ground / Uziemnienie White / Biały	3
Direction indicator / Kierunkowskaz Green / Zielony	4
Rear position light / Światło pozycyjne tylne Brown / Brązowy	5
Stop light / Światło stop Red / Czerwony	6
Reversing light / Światło cofania Gray / Szary	8

## FT-370 LED

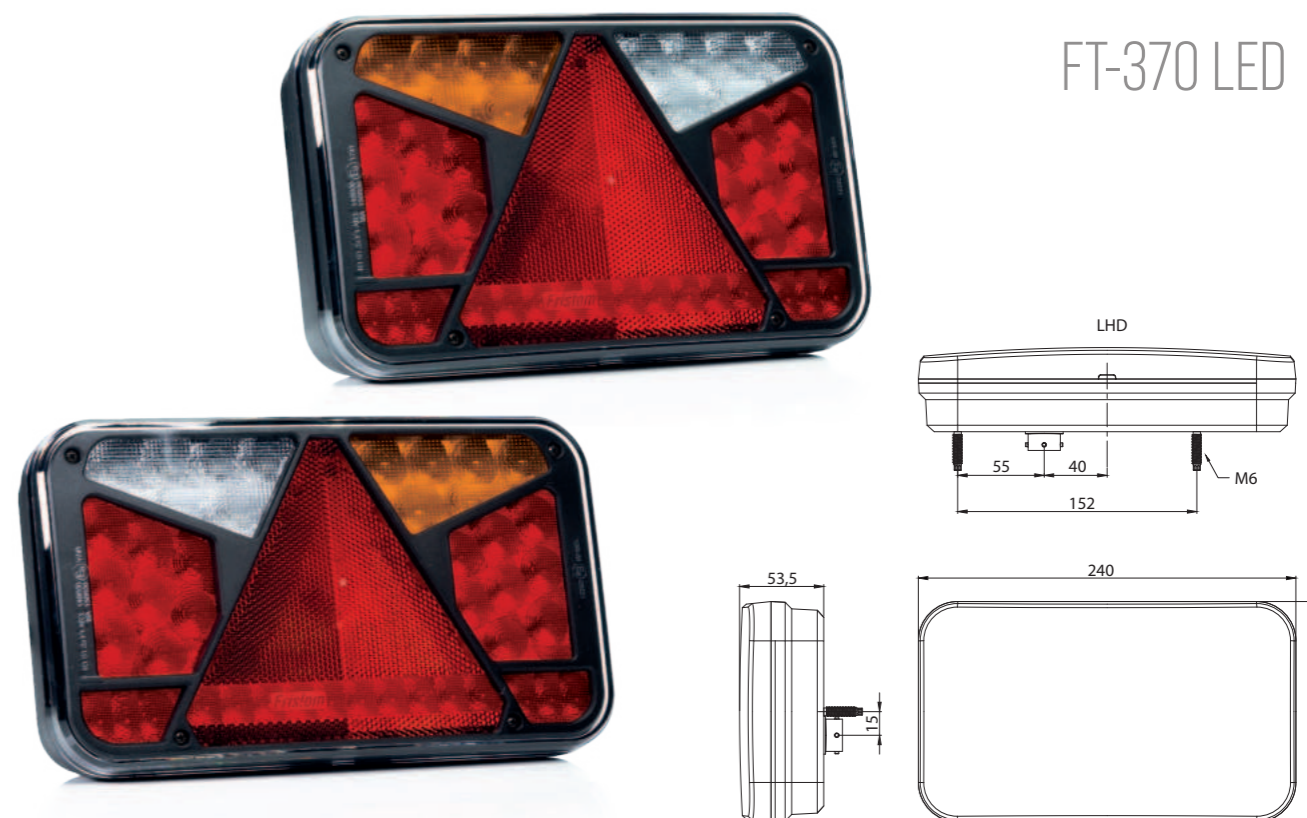

# ONE lamp, TWO faces!

### LIGHT CONTROL SYSTEM

Universal LED lamp – low power consumption  
 European homologation E9  
 ElectroMagnetic Compatibility (EMC) homologate on  
 shock-resistance – PC lampshade  
 reverse polarity protection system

#### Lamp functions:

- rear running light
- STOP light
- indicator
- fog light
- reversing light
- number plate light (depending on the version)
- reflector (triangle) kat. IIIA

#### Technical specification:

- supply voltage: 12–36V DC, ( FT-371 LED 0: 12–15V DC)
- operating temperature: –40°C to +55°C
- lamp is resistant to any weather conditions
- lamp is fully airtight

#### Power consumption:

- rear running light: 12V/24V – 0.1A/0.1A
- STOP light: 12V/24V – 0.15A/0.08A
- indicator: 12V/24V – 0.3A/0.3A
- reversing light: 12V/24V – 0.2A/0.1A
- fog light: 12V/24V – 0.3A/0.15A

#### Power consumption / Rated power:

- rear running light: 12V/24V – 1.5W/3W
- STOP light: 12V/24V – 2W/2.2W
- indicator: 12V/24V – 4W/8W
- reversing light: 12V/24V – 3W/3.2W
- fog light: 12V/24V – 4W/4.2W

#### FT-370 LED

- 12V/24V – 0.1A/0.1A
- 12V/24V – 0.15A/0.08A
- 12V/24V – 0.3A/0.3A
- 12V/24V – 0.2A/0.1A
- 12V/24V – 0.3A/0.15A

#### FT-370 LED 0

with light control system  
 – system CANBUS

- 12V = 0.4A
- 12V = 0.55A
- 12V = 1.2A
- 12V = 0.3A
- 12V = 0.3A

- 12V = 5W
- 12V = 7W
- 12V = 15W
- 12V = 4W
- 12V = 4W

#### PRODUCTION:

FRISTOM  
 Spółka z ograniczoną odpowiedzialnością i Sp. K.  
 ul. Przemysłowa 5  
 POLAND, 86-014 Sicienko

#### EXPORT:

mobile +48 609 909 456  
 bstaniaszek@fristom.com.pl  
 mobile +48 731 088 883  
 wtomczak@fristom.com.pl

mobile +48 607 843 275  
 rcardona@fristom.com.pl  
 mobile +48 794 792 929  
 mjanus@fristom.com.pl

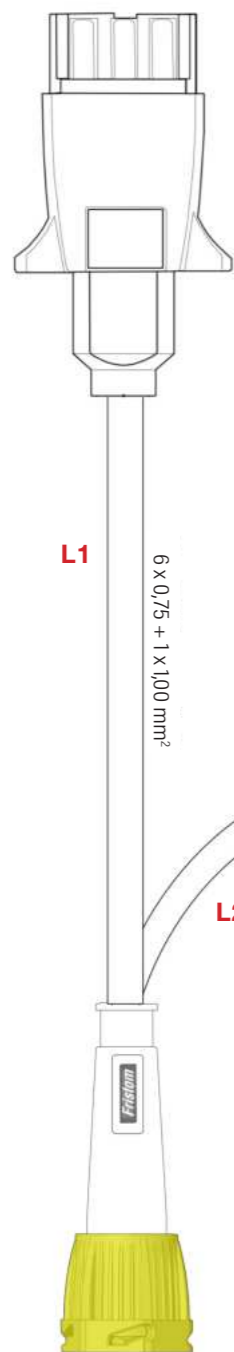

Plug 7 Pins Innerwork / Wtyk 7 Pinów  
Plug view / Widok od wtyczki / ISO 1724

1	Left direction indicator / Kierunkowskaz lewy Yellow / Żółty
2	Fog / Światło przeciwmgłowe Blue / Niebieski
3	Ground / Uziemnienie White / Biały
4	Right direction indicator / Kierunkowskaz prawy Green / Zielony
5	Right position light / Światło pozycyjne prawe Brown / Brązowy
6	Stop light / Światło stop Red / Czerwony
7	Left position light / Światło pozycyjne lewe Black / Czarny

#### 4-FUNCTIONAL LAMP:

- STOP LIGHT
- REAR POSITION LIGHT
- INDICATOR
- FOG LIGHT

#### 3-FUNCTIONAL LAMP:

- STOP LIGHT
- REAR POSITION LIGHT
- INDICATOR

BAJONET 5 PIN  
Yellow / Żółty  
Plug view / Widok wtyczki

Direction indicator / Kierunkowskaz Yellow / Żółty	1	
Fog / Światło przeciwmgłowe Blue / Niebieski	2	
Ground / Uziemnienie White / Biały	3	
Stop light / Światło stop Red / Czerwony	4	
Rear position light / Światło pozycyjne tylne Black / Czarny	5	

BAJONET 4 PIN  
Green / Zielony  
Plug view / Widok wtyczki

Ground / Uziemnienie White / Biały	3	
Direction indicator / Kierunkowskaz Green / Zielony	4	
Rear position light / Światło pozycyjne tylne Brown / Brązowy	5	
Stop light / Światło stop Red / Czerwony	6	



- Universal LED rear lamp – low power consumption
- european E9 homologation
  - ElectroMagnetic Compatibility – EMC certificate
  - shock-resistance – PC lampshade
  - reverse polarity protection system

- Lamp functions:
- rear position light
  - number plate light
  - STOP light
  - indicator

#### Technical specification:

- supply voltage: 12–15V DC
- operating temperature: –40°C to +55°C
- lamp is resistant to any weather conditions
- lamp is fully airtight

#### Power consumption:

- rear position light + license plate light: 12V = 0.1A
- version without number plate light: 12V = 0.05A
- STOP light 12V = 0.2A
- indicator 12V = 0.2A

#### Power consumption / Rated power:

- rear position light + license plate light: 12V = 1.2W
- version without number plate light: 12V = 0.6W
- STOP light 12V = 2.4W
- indicator 12V = 2.4W

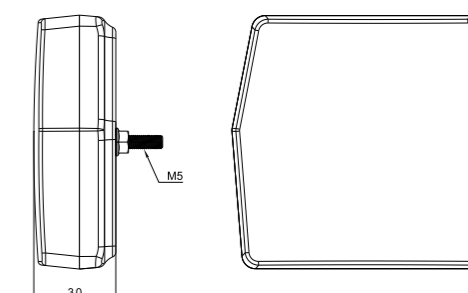
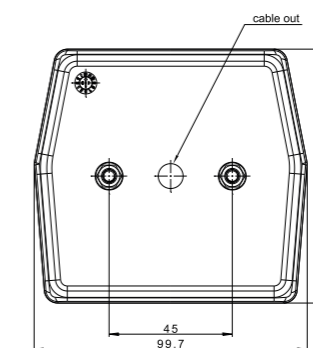
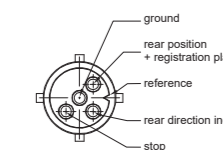
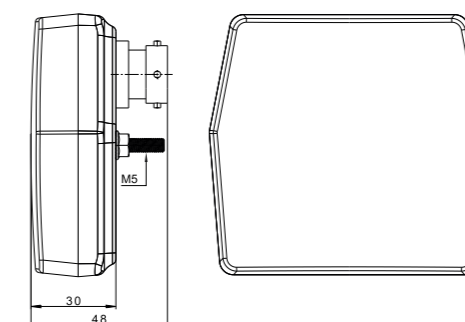
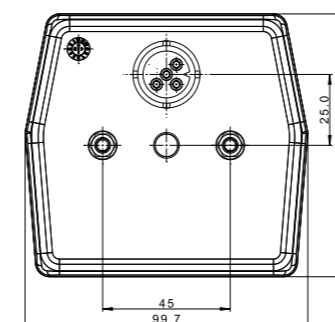

PRODUCTION:  
FRISTOM  
Spółka z ograniczoną odpowiedzialnością i Sp. K.  
ul. Przemysłowa 5  
POLAND, 86-014 Sicienko

EXPORT:  
mobile +48 609 909 456  
bstaniaszek@fristom.com.pl  
mobile +48 731 088 883  
wtomczak@fristom.com.pl

mobile +48 607 843 275  
rcardona@fristom.com.pl  
mobile +48 794 792 929  
mjanus@fristom.com.pl

### LED Control System

FT-700 LED

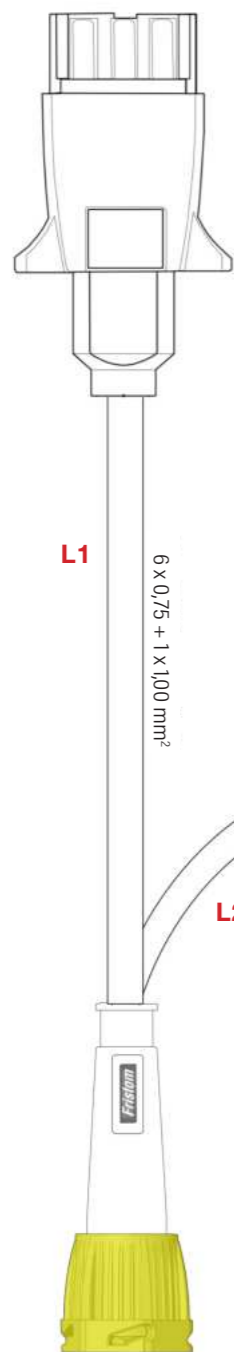

Plug 7 Pins Innerwork / Wtyk 7 Pinów  
Plug view / Widok od wtyczki / ISO 1724

	1	Left direction indicator / Kierunkowskaz lewy Yellow / Żółty
	2	Fog / Światło przeciwmgłowe Blue / Niebieski
	3	Ground / Uziemnienie White / Biały
	4	Right direction indicator / Kierunkowskaz prawy Green / Zielony
	5	Right position light / Światło pozycyjne prawe Brown / Brązowy
	6	Stop light / Światło stop Red / Czerwony
	7	Left position light / Światło pozycyjne lewe Black / Czarny

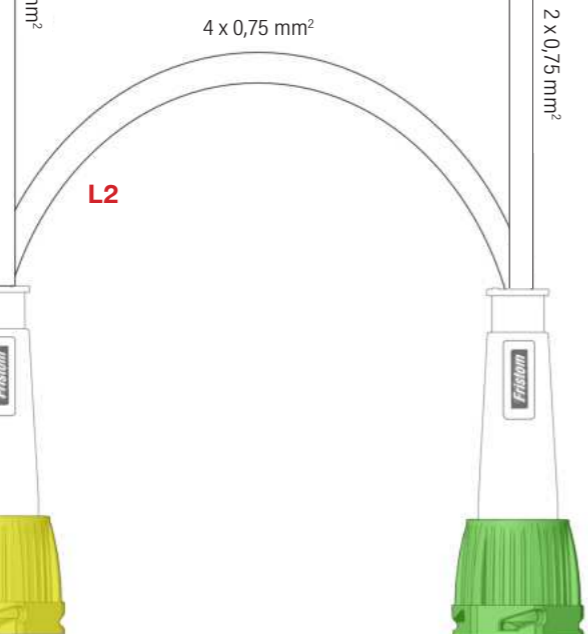

#### 3-FUNCTIONAL LAMP:

STOP LIGHT  
REAR POSITION LIGHT  
INDICATOR

#### 3-FUNCTIONAL LAMP:

STOP LIGHT  
REAR POSITION LIGHT  
INDICATOR

BAYONET 5 PIN  
Yellow / Żółty  
Plug view / Widok wtyczki

Direction indicator / Kierunkowskaz Yellow / Żółty	1	
Fog / Światło przeciwmgłowe Blue / Niebieski	2	
Ground / Uziemnienie White / Biały	3	
Stop light / Światło stop Red / Czerwony	6	
Rear position light / Światło pozycyjne tyłne Black / Czarny	7	

BAYONET 4 PIN  
Green / Zielony  
Plug view / Widok wtyczki

Ground / Uziemnienie White / Biały	3	
Direction indicator / Kierunkowskaz Green / Zielony	4	
Rear position light / Światło pozycyjne tyłne Brown / Brązowy	5	
Stop light / Światło stop Red / Czerwony	6	



6-functional universal LED lamp – low power consumption  
ABS enclosure with M8 neck bolts  
Optimised light performance – the patented Amphenol pressure bleeding valve  
Reverse polarity protection system

#### Lamp functions:

- rear running light
- STOP light
- indicator
- reversing light
- fog light
- reflector

#### Lamp parameters:

- supply voltage: 24V DC
- operating temperature: -40°C to +55°C
- lamp is resistant to any weather conditions
- lamp is fully airtight

#### Power consumption:

- rear light: 24V = 0.2A
- STOP light: 24V = 0.8A
- indicator: 24V = 0.85A
- reversing light: 24V = 0.25A
- fog light: 24V = 0.2A

#### Power consumption / Rated power:

- rear light: 24V = 5W
- STOP light: 24V = 20W
- indicator: 24V = 21W
- reversing light: 24V = 6.5W
- fog light: 24V = 5W

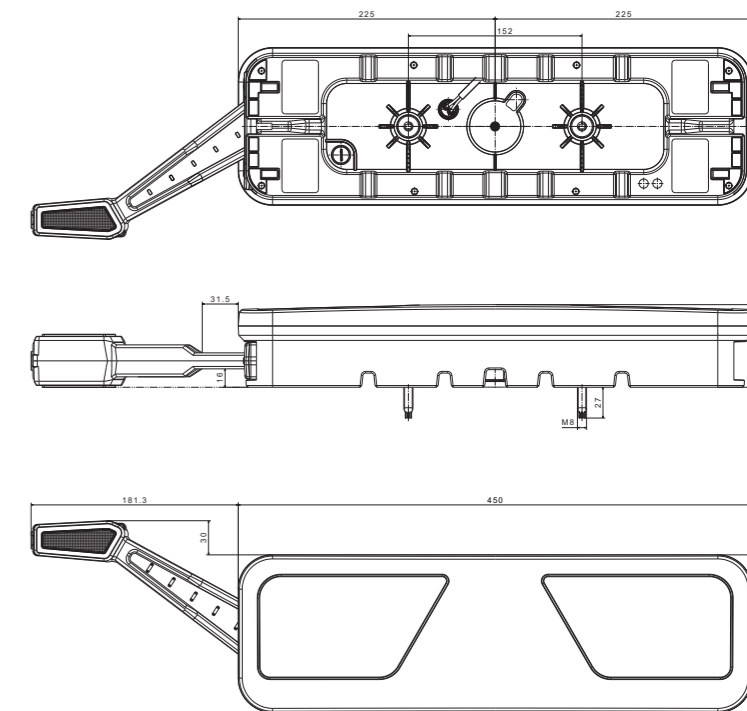

PRODUCTION:  
FRISTOM  
Spółka z ograniczoną odpowiedzialnością i Sp. K.  
ul. Przemysłowa 5  
POLAND, 86-014 Sicienka

EXPORT:  
mobile +48 609 909 456  
bstaniaszek@fristom.com.pl  
mobile +48 731 088 883  
wtomczak@fristom.com.pl

mobile +48 607 843 275  
rcardona@fristom.com.pl  
mobile +48 794 792 929  
mjanus@fristom.com.pl

Plug 7 Pins Innerwork / Wtyk 7 Pinów  
Plug view / Widok od wtyczki / ISO 1724

	1	Left direction indicator / Kierunkowskaz lewy Yellow / Żółty
	2	Fog / Światło przeciwmgłowe Blue / Niebieski
	3	Ground / Uziemnienie White / Biały
	4	Right direction indicator / Kierunkowskaz prawy Green / Zielony
	5	Right position light / Światło pozycyjne prawe Brown / Brązowy
	6	Stop light / Światło stop Red / Czerwony
	7	Left position light / Światło pozycyjne lewe Black / Czarny

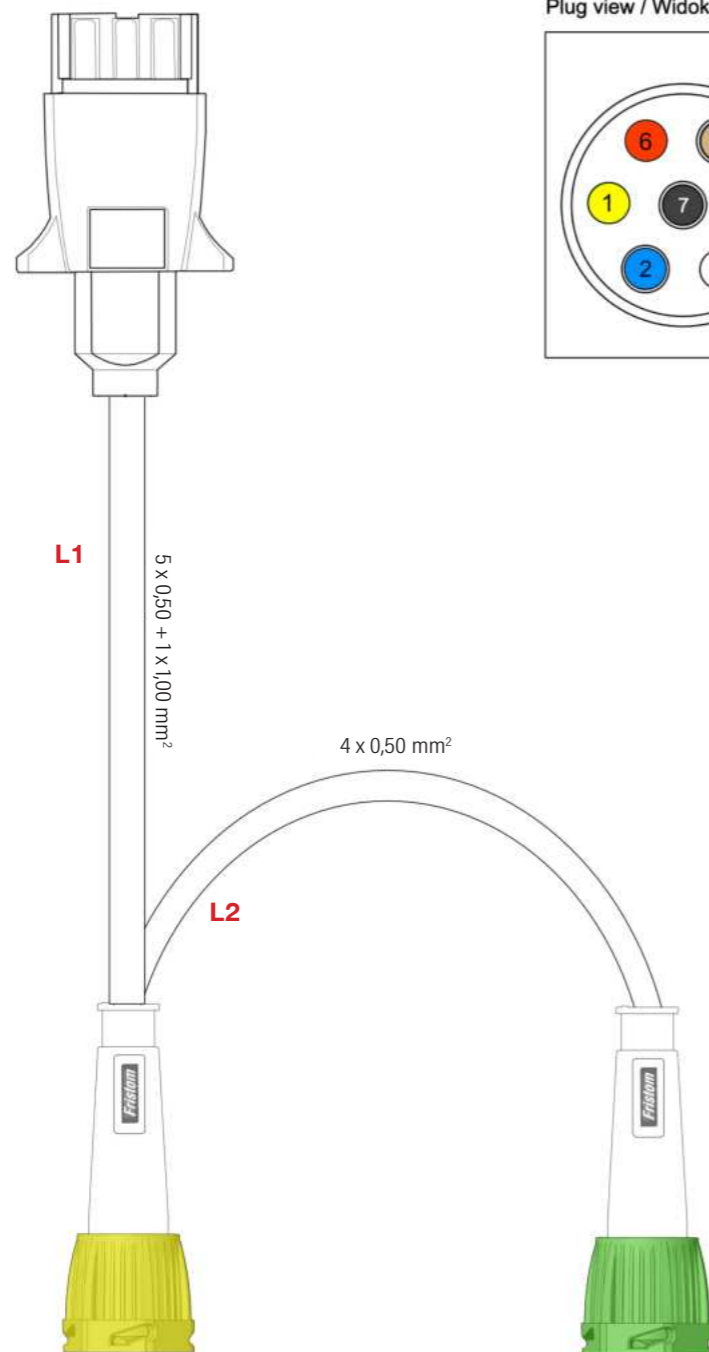

#### 3-FUNCTIONAL LAMP:

STOP LIGHT  
REAR POSITION LIGHT  
INDICATOR

#### 3-FUNCTIONAL LAMP:

STOP LIGHT  
REAR POSITION LIGHT  
INDICATOR

BAJONET 4 PIN  
Yellow / Żółty  
Plug view / Widok wtyczki

Direction indicator / Kierunkowskaz Yellow / Żółty	1	
Ground / Uziemnienie White / Biały	3	
Stop light / Światło stop Red / Czerwony	6	
Rear position light / Światło pozycyjne tylne Black / Czarny	7	

BAJONET 4 PIN  
Green / Zielony  
Plug view / Widok wtyczki

Ground / Uziemnienie White / Biały	3	
Direction indicator / Kierunkowskaz Green / Zielony	4	
Rear position light / Światło pozycyjne tylne Brown / Brązowy	5	
Stop light / Światło stop Red / Czerwony	6	

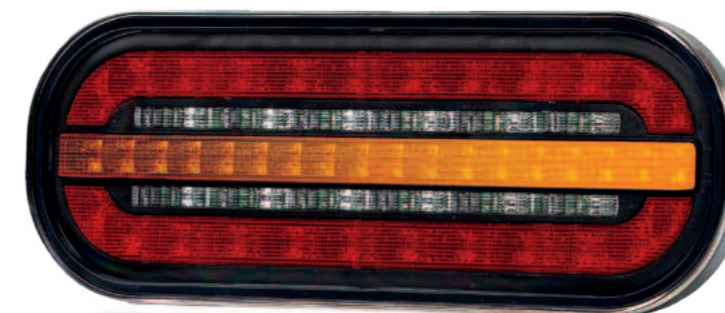

**dynamic indicator**

3-functional LED lamp – low power consumption  
European homologation **E9** – horizontal assembly only  
ElectroMagnetic Compatibility (EMC); **R10** homologation  
Shock-resistance – PC lampshade  
Reverse polarity protection system  
Dynamic indicator

#### Lamp functions:

- Rear running light
- STOP light
- Indicator

#### Technical specification:

- supply voltage: **12–36V DC**
- operating temperature: **-40°C to +55°C**
- lamp is resistant to any weather conditions
- lamp is fully airtight

#### Power consumption:

- rear running light: **12V/24V = 0.1A/0.1A**
- STOP light: **12V/24V = 0.2A/0.2A**
- indicator: **12V/24V = 0.35A/0.35A**

#### Power consumption (rated power):

- rear running light: **12V/24V = 1.5W/3W**
- STOP light: **12V/24V = 2.5W/5W**
- indicator: **12V/24V = 4.5W/9W**

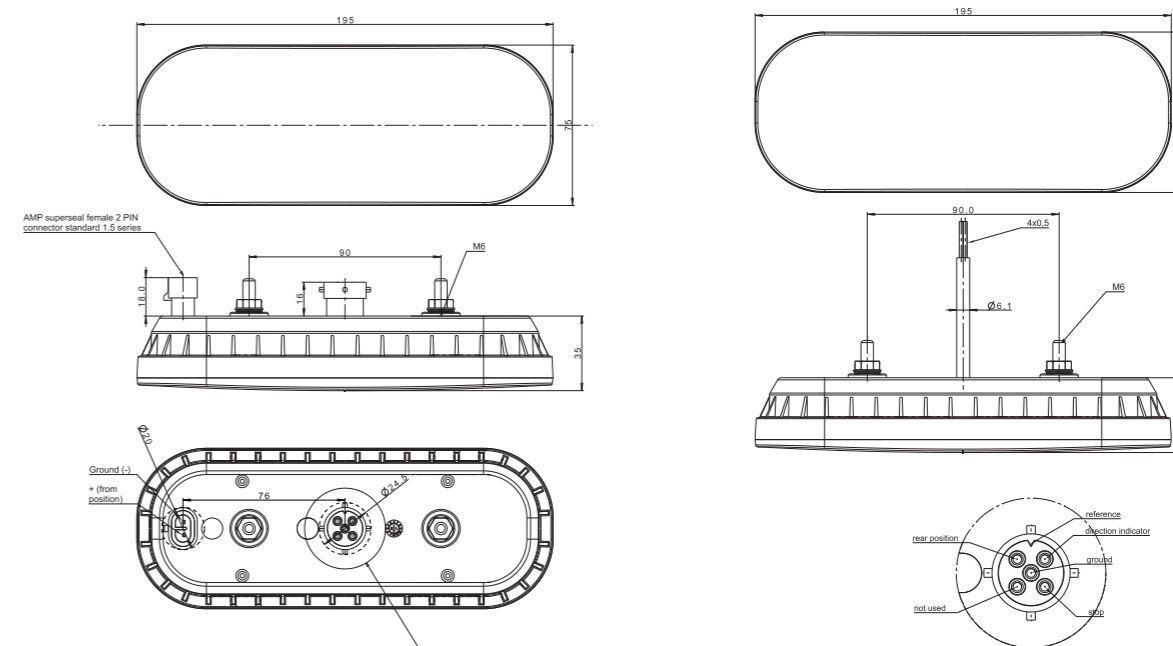

PRODUCTION:  
FRISTOM  
Spółka z ograniczoną odpowiedzialnością i Sp. K.  
ul. Przemysłowa 5  
POLAND, 86-014 Sicienka

EXPORT:  
mobile +48 609 909 456  
bstaniaszek@fristom.com.pl  
mobile +48 731 088 883  
wtomczak@fristom.com.pl

mobile +48 607 843 275  
rcardona@fristom.com.pl  
mobile +48 794 792 929  
mjanus@fristom.com.pl

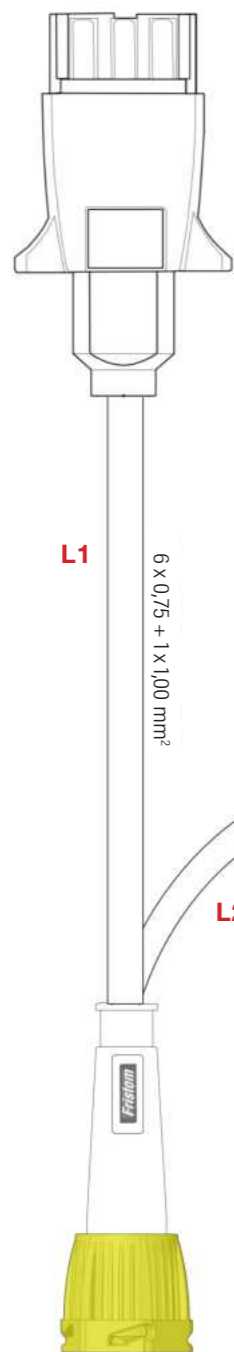

Plug 7 Pins Innerwork / Wtyk 7 Pinów  
Plug view / Widok od wtyczki / ISO 1724

1	Left direction indicator / Kierunkowskaz lewy Yellow / Żółty
2	Fog / Światło przeciwmgłowe Blue / Niebieski
3	Ground / Uziemnienie White / Biały
4	Right direction indicator / Kierunkowskaz prawy Green / Zielony
5	Right position light / Światło pozycyjne prawe Brown / Brązowy
6	Stop light / Światło stop Red / Czerwony
7	Left position light / Światło pozycyjne lewe Black / Czarny

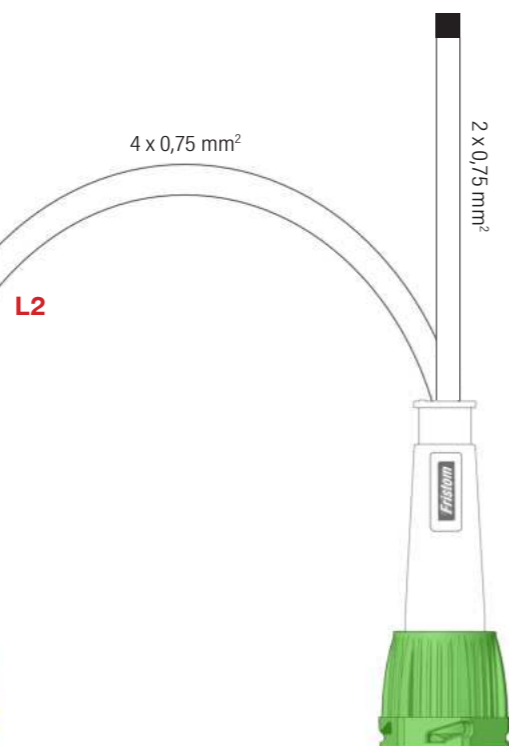

### 3-FUNCTIONAL LAMP:

STOP LIGHT  
REAR POSITION LIGHT  
INDICATOR

### 3-FUNCTIONAL LAMP:

STOP LIGHT  
REAR POSITION LIGHT  
INDICATOR

BAYONET 4 PIN  
Yellow / Żółty  
Plug view / Widok wtyczki

Direction indicator / Kierunkowskaz Yellow / Żółty	1
Ground / Uziemnienie White / Biały	3
Stop light / Światło stop Red / Czerwony	6
Rear position light / Światło pozycyjne tylne Black / Czarny	7

BAYONET 4 PIN  
Green / Zielony  
Plug view / Widok wtyczki

Ground / Uziemnienie White / Biały	3
Direction indicator / Kierunkowskaz Green / Zielony	4
Rear position light / Światło pozycyjne tylne Brown / Brązowy	5
Stop light / Światło stop Red / Czerwony	6

## FT-330 LED

3-functional LED lamp

### Lamp FUNCTIONS:

- rear running light
- STOP light
- indicator

#### Power consumption:

- rear running light: 12V/24V = 0.02A/0.02A
- STOP light: 12V/24V = 0.08A/0.08A
- indicator: 12V/24V = 0.06A/0.06A

#### Power consumption / Rated power:

- rear running light: 12V/24V = 0.25W/0.5W
- STOP light: 12V/24V = 1W/2W
- indicator: 12V/24V = 0.8W/1.5W

## FT-331 LED

2-functional LED lamp

### Lamp FUNCTIONS:

- front position light
- indicator (cat.1)

#### Power consumption:

- front position light 12V/24V = 0.02A/0.02A
- indicator: 12V/24V = 0.15A/0.15A

#### Power consumption / Rated power:

- front position light: 12V/24V = 0.25W/0.5W
- indicator: 12V/24V = 1.8W/3.6W

## FT-332 LED

1-functional LED lamp

### Lamp FUNCTIONS:

- fog light

#### Power consumption:

- fog light:  
12V/24V = 0.2A/0.1A

#### Power consumption / Rated power:

- fog light:  
12V/24V = 2.5W/2.5W

### Vertical / horizontal approval



*The smallest 3-function  
LED rear lamp in our offer!*

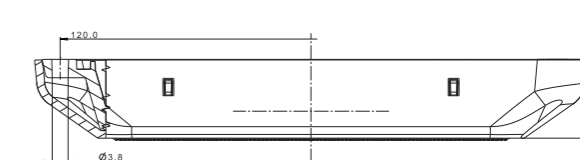
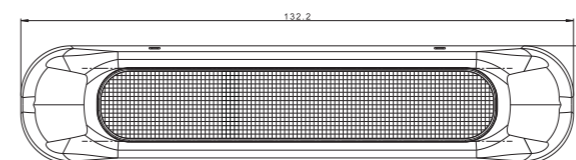

PRODUCTION:  
FRISTOM  
Spółka z ograniczoną odpowiedzialnością i Sp. K.  
ul. Przemysłowa 5  
POLAND, 86-014 Sicienka

EXPORT:  
mobile +48 609 909 456  
bstaniaszek@fristom.com.pl  
mobile +48 731 088 883  
wtomczak@fristom.com.pl

mobile +48 607 843 275  
rcardona@fristom.com.pl  
mobile +48 794 792 929  
mjanus@fristom.com.pl

Plug 13 Pins Innerwork / Wtyk 13 Pinów  
Plug View / Widok od wtyczki / ISO 11446

	1	Lewe światło kierunku jazdy (żółty) Left direction indicator light (yellow)
	2	Światło przeciwmgłowe (niebieski) Fog light (blue)
	3	Masa (biała) Mass (white)
	4	Prawe światło kierunku jazdy (zielony) Right direction indicator light (green)
	5	Światło pozycyjne prawe (brązowy) Right position light (brown)
	6	Światła hamowania (STOP) (czerwony) Brake light (STOP) (RED)
	7	Światło pozycyjne lewe (+ oświetlenie tablicy rejestracyjnej, światła obrotowe) (czarny) Left position light (+ number plate light, clearance light) (black)
	8	Światło cofania (szary) Reversing light (gray)

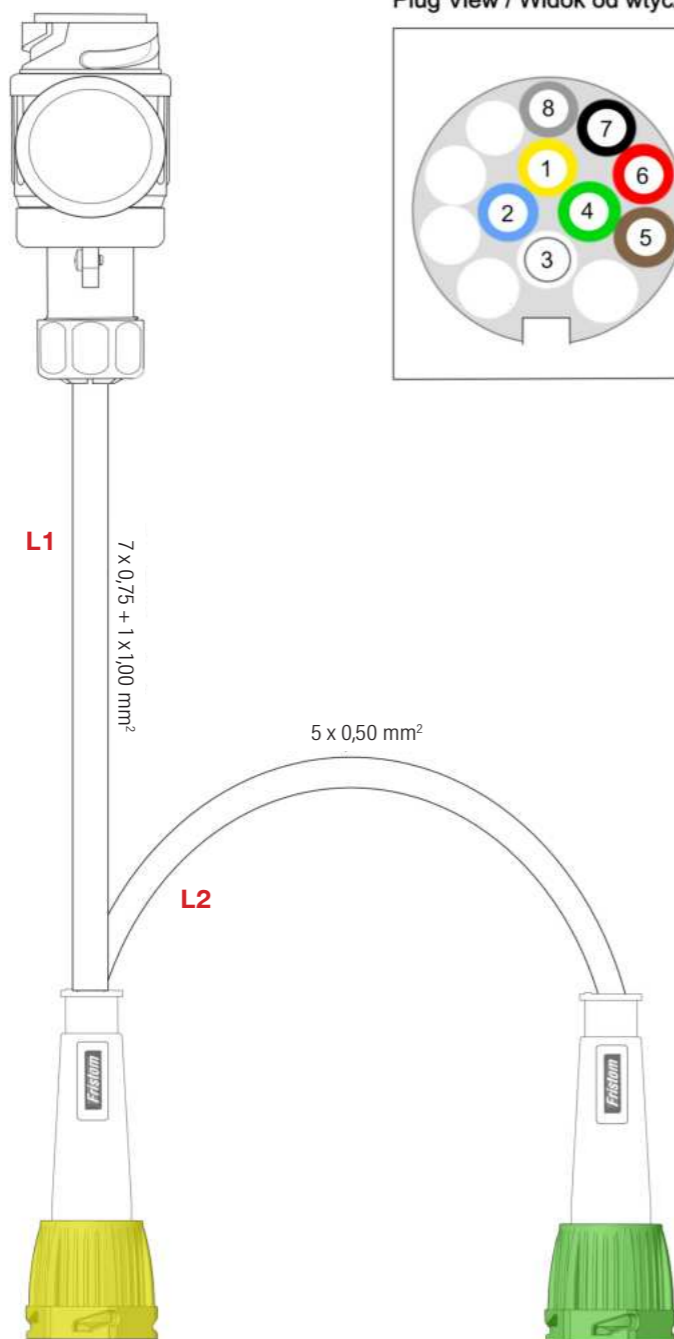

**4-FUNCTIONAL LAMP:**

- STOP LIGHT
- REAR POSITION LIGHT
- INDICATOR
- FOG LIGHT

**4-FUNCTIONAL LAMP:**

- STOP LIGHT
- REAR POSITION LIGHT
- INDICATOR
- REVERSING LIGHT

BAJONET 5 PIN  
Yellow / Żółty  
Plug view / Widok wtyczki

Direction indicator / Kierunkowskaz Yellow / Żółty	1	
Fog / Światło przeciwmgłowe Blue / Niebieski	2	
Ground / Uziemnienie White / Biały	3	
Stop light / Światło stop Red / Czerwony	6	
Rear position light / Światło pozycyjne tylne Black / Czarny	7	

BAJONET 5 PIN  
Green / Zielony  
Plug view / Widok wtyczki

Ground / Uziemnienie White / Biały	3	
Direction indicator / Kierunkowskaz Green / Zielony	4	
Rear position light / Światło pozycyjne tylne Brown / Brązowy	5	
Stop light / Światło stop Red / Czerwony	6	
Reversing light / Światło cofania Gray / Szary	8	

FT-262 LED



FT-260 LED



FT-263 LED



FT-263/1 LED



PRODUCTION:  
FRISTOM  
Spółka z ograniczoną odpowiedzialnością i Sp. K.  
ul. Przemysłowa 5  
POLAND, 86-014 Sicienka

EXPORT:  
mobile +48 609 909 456  
bstaniaszek@fristom.com.pl  
mobile +48 731 088 883  
wtomczak@fristom.com.pl

mobile +48 607 843 275  
rcardona@fristom.com.pl  
mobile +48 794 792 929  
mjanus@fristom.com.pl

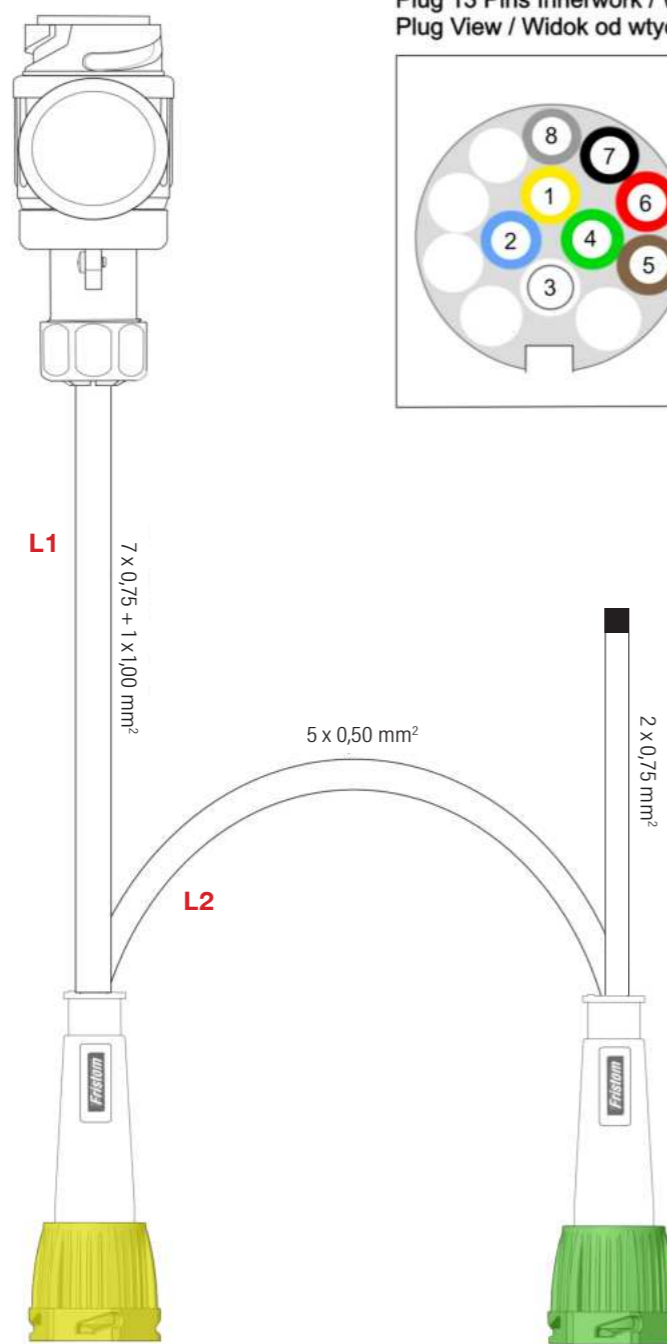

**4-FUNCTIONAL LAMP:**

- STOP LIGHT
- REAR POSITION LIGHT
- INDICATOR
- FOG LIGHT

**4-FUNCTIONAL LAMP:**

- STOP LIGHT
- REAR POSITION LIGHT
- INDICATOR
- REVERSING LIGHT

Plug 13 Pins Innerwork / Wtyk 13 Pinów  
Plug View / Widok od wtyczki / ISO 11446

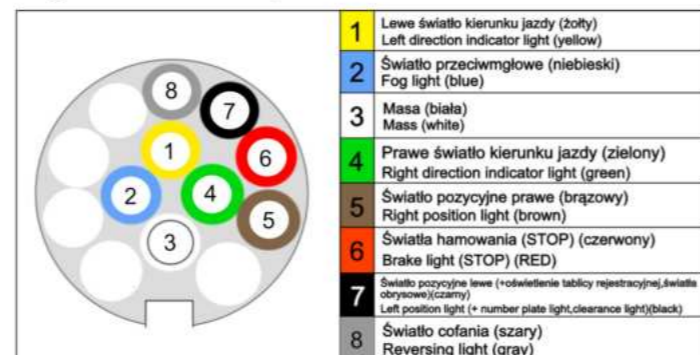

Plug 7 Pins Innerwork / Wtyk 7 Pinów  
Plug view / Widok od wtyczki / ISO 1724

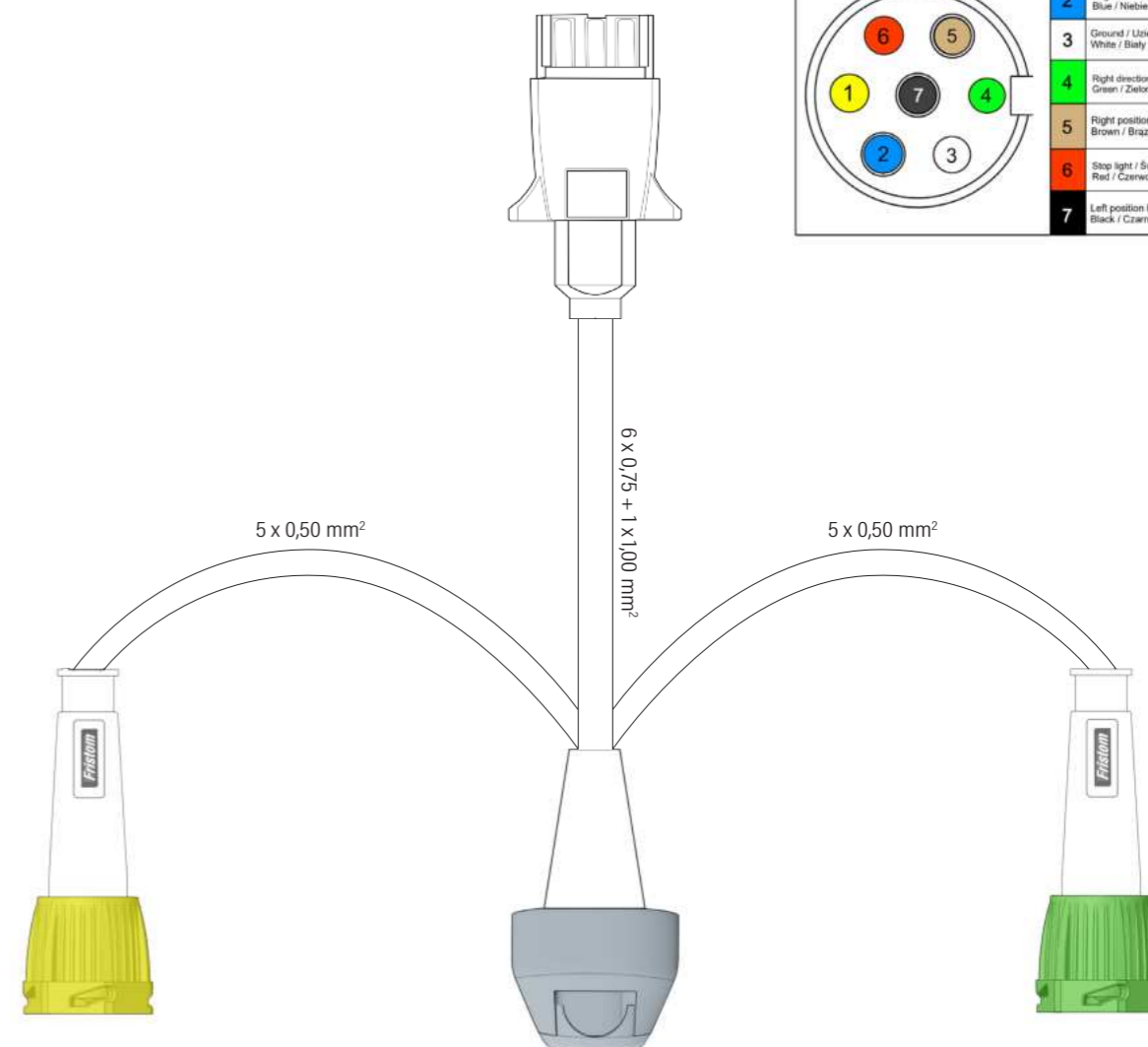
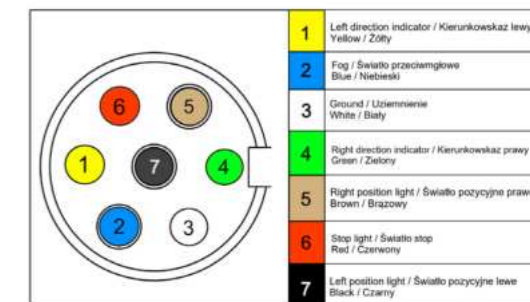

**4-FUNCTIONAL LAMP:**

- STOP LIGHT
- REAR POSITION LIGHT
- INDICATOR
- FOG LIGHT

**4-FUNCTIONAL LAMP:**

- STOP LIGHT
- REAR POSITION LIGHT
- INDICATOR
- FOG LIGHT

Socket 7 Pins / Gniazdo 7 Pinów  
Plug view / Widok od wtyczki



BAJONET 5 PIN  
Yellow / Żółty  
Plug view / Widok wtyczki



BAJONET 5 PIN  
Green / Zielony  
Plug view / Widok wtyczki



BAYONET 5 PIN  
Yellow / Żółty  
Plug view / Widok wtyczki



BAYONET 5 PIN  
Green / Zielony  
Plug view / Widok wtyczki







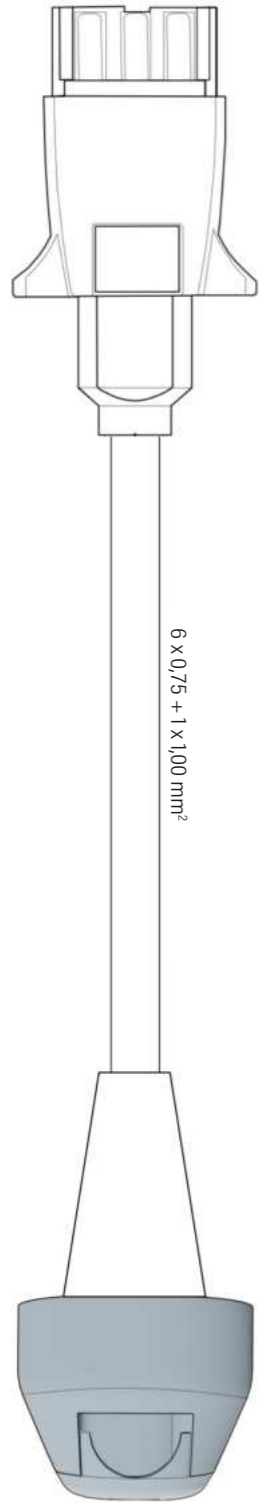

**Plug 7 Pins Innerwork / Wtyk 7 Pinów**  
 Plug view / Widok od wtyczki / ISO 1724

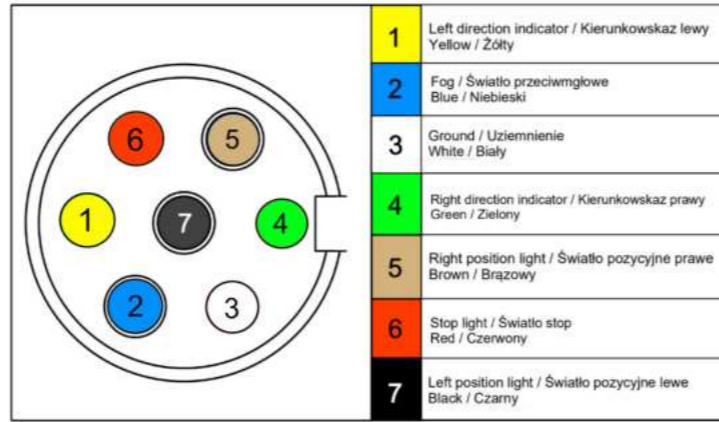

**Socket 7 Pins / Gniazdo 7 Pinów**  
 Plug view / Widok od wtyczki

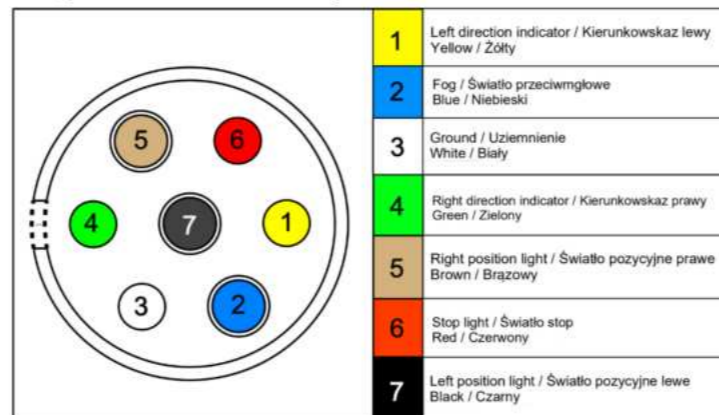

**Plug 7 Pins Innerwork / Wtyk 7 Pinów**  
 Plug view / Widok od wtyczki / ISO 1724

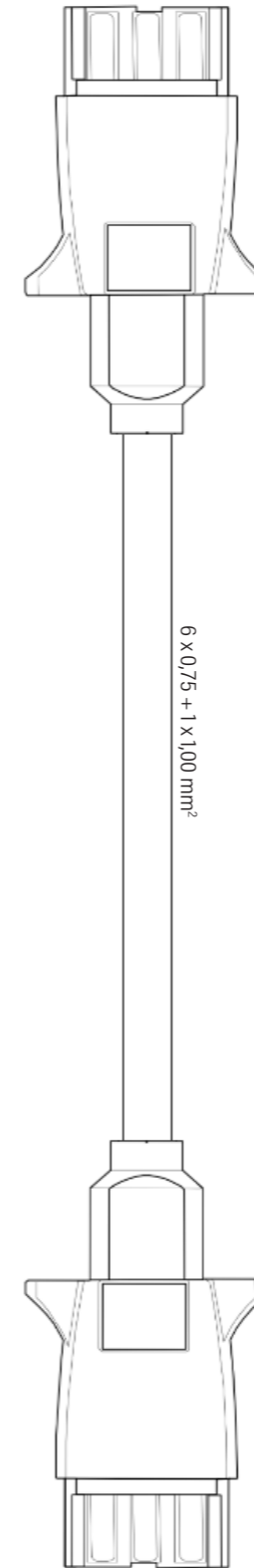
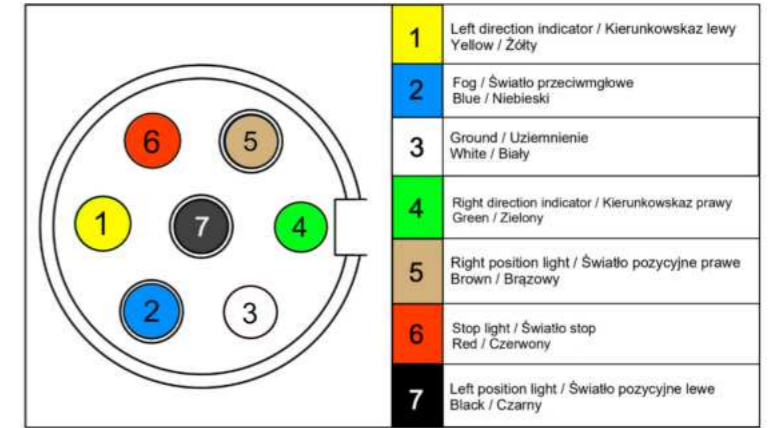

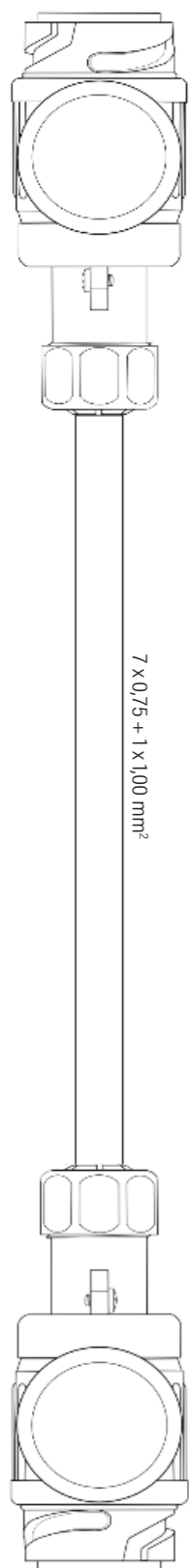

Plug 13 Pins Innerwork / Wtyk 13 Pinów  
Plug View / Widok od wtyczki / ISO 11446

	1	Lewe światło kierunku jazdy (żółty) Left direction indicator light (yellow)
	2	Światło przeciwmgłowe (niebieski) Fog light (blue)
	3	Masa (biała) Mass (white)
	4	Prawe światło kierunku jazdy (zielony) Right direction indicator light (green)
	5	Światło pozycyjne prawe (brązowy) Right position light (brown)
	6	Światła hamowania (STOP) (czerwony) Brake light (STOP) (RED)
	7	Światło pozycyjne lewe (+oświetlenie tablicy rejestracyjnej, światła obrysowe)(czarny) Left position light (+ number plate light, clearance light)(black)
	8	Światło cofania (szary) Reversing light (gray)



**PRODUCTION:**  
FRISTOM  
Spółka z ograniczoną odpowiedzialnością i Sp. K.  
ul. Przemysłowa 5  
POLAND, 86-014 Sicienko

**EXPORT:**  
mobile +48 609 909 456  
bstaniaszek@fristom.com.pl  
mobile +48 731 088 883  
wtomczak@fristom.com.pl

mobile +48 607 843 275  
rcardona@fristom.com.pl  
mobile +48 794 792 929  
mjanus@fristom.com.pl



***Fristom***

**FRISTOM**  
Spółka z ograniczoną odpowiedzialnością Sp. k.

POLSKA  
ul. Przemysłowa 5  
86-014 Sicienko



[www.fristom.com](http://www.fristom.com)